



NANBA

GROUP

www.nanbagroup.com

Think Quality, Think NANBA!

BADGES, UNIFORM ACCESSORIES & ACCOUTREMENTS, GLOVES

Since 1992 | Edding Elegance



NANABA

GROUP

www.nanbagroup.com

Think Quality
Think NANBA...



Start Your Day
With
NANBA Thought

NANBA believes "To Be Different, To Be Succeeded"

About Us

» Dear Valued Customers

We are very excited and pleased to present the fresh addition of our printing catalogue that covers range of products such as "Badges, Uniform Accessories & Accoutrements" an outcome of our dedicated team to convenient our clients.

NANBA was formed in 1992 by late Mr. Muhammad Ayub, his robust efforts brought the company on international face in no time to serve some major clients in UK, U.A.E, Singapore, Japan, Europe & U.S.A. Company achieved its first recognition in 1999 and then in 2003 simultaneously and from that year onwards NANBA is recognized as most convenient, trustworthy, understanding and reliable business partner known as "A business partner that listens more than one speaks" with its slogan - Think Quality, Think NANBA!

We have very competent and expert "Quality Control Department" with proper training and equipment because of whom they have very deep and keen eye over the details and artwork of the product, as a matter of fact, quality is guaranteed and assured to every buyer before dispatching goods to our worldwide customer, since every single product undergoes a strict quality check system with its dual quality check phenomena.

We are ISO 9001-2015 registered company for Quality Management System as well as ISO 14001-2015 registered company for environmental Management System.

Our Products Range is as follows:

» Badges (Bullion, Metal, Machine, Woven, Rubber)

Handmade Uniform Bullion & Thread Badges, Family Crests (Coat of Arms), Gorgets and Cuff Titles, Wings & Patches, Emblems, Insignias, Cap Badges, Embroidered Sashes, Embroidered Buttons, Banners & Flags, Army/Air-force/Navy/Police/Fire Department & Law Enforcement Badges, Embroidered Peaks & Visors, Clubs/Schools/Colleges & Universities Badges, Bullion Shoulder Boards, Ranks & Regimental Badges, Embroidered Key Rings, Collar Tabs, Pennants, Navy Insignias, Embroidered Pillows, Woven Badges & Labels, Machine Embroidery Badges, Metal Badges, Rubber Logos Etc.

» Uniform Accessories & Accoutrements

Aiguillettes & Shoulder Cords, Lanyards & Whistle Cords, Snate Cords & Cord Shoulders, Dress Cords, Bugles & Bugle Cords, Tassels & Tassel Cords, Fringes, Cords, Braids, Swords & Sword Knots, Medals, Ribbons, Rosettes, Bars Etc. Peak Caps & Berets, Shoulder, Epaulettes, Sliders, Chevrons, Sashes, Gorgets, Belts & Buckles, Leather Wallets/Bags Brassards, Arm Bands, Gaiters, Chin Cords & Hat Cords, Ribbons & Webbing, Metallic & French Braids, Canvas/Nylon/Webbing & Leather Belts, Belly Sashes, Plumes & Hackles, Balmorals & Glengarries, Navy & Marching Caps, Ceremonial Waist Belts, Printed Flags, Bullion & Cord shoulders, Command & Pace Sticks, Ties, Cumberbund & Scarves, Ceremonial Gloves & Gauntlets, Officer Leather Sword Belts, Waist & Shoulder Sashes, Flag Stands & Shields, Lodge & Ceremonial Decorated Items, Uniform Trimmings, Beads Etc.

» Histroy Costumes, Epic & Theatre Tunics, Dresses & Uniforms/Regalia

Civilwar Confederate & Union Costumes as well as Headwear & Accessories, Band Uniforms, Epic & Theatre Productions includes dresses and accessories products, European Era Clothings, Victorian costumes, History movies and film supplies, Scouts Uniforms & Products, Ceremonial Tunics, Etc. Aprons (imitation, leather, lambskin) Sashes, Gauntlets (Machine & Bullion Embroidery) Collors & Collarettes, Fezes and Caps, Jewels & Chain Collars, Gloves & Gauntlets, Ties, Bow Ties, Romals, T-shirts & Polo Shirts, Briefcases, Cap Cases, File Cases, Fez Cases, Chain collar cases Etc. We supply to all major institutions like that of English Constitution, Victorian & Irish Regalia, European Regalia, Blue Lodge & OES, Canadian & Australia Regalia & much more...

» Our Policy

Competitive Price, Quality Assurance & Timely Delivery.

» Services

We assure best services to all our clients and try our utmost to respond them ASAP. We can be reached by phone, fax, e-mail, mobile etc. We are sure that our customers would be fully satisfied with our service quality and feel confident enough to establish consistent and trustworthy business collaboration. We do not look for just one time sale, we seek the clients whom we could develop good business relationships forever.

» Message

The products series on this catalogue are a few selections out of many we made from years. If you don't see what you are looking for please write us we may certainly assist you.

Thanks for your precious time.

NANBA TEAM!

NANBA
GROUP

www.nanbagroup.com

Message

L.C.E.O

» MESSAGE

” NANBA represents a varied spectrum that intelligently and economically combines high quality products of “Badges, Uniform Accessories & Accoutrements” owes its standing amongst the best in business to its clients and partners.

Thus, NANBA is much more than merely a supplier, a partner who listens carefully and contributes ideas, who understands customer’s needs & requirements providing them a high level assistance.

From products to services, from assistance to accomplishment.

Our manufacturing process; a combination of best material and craftsmanship. After all, at NANBA we have been known since 1992, number of years of excellence!

NANBA FROM PAKISTAN feels proud to serve you. ”



Mr. Naeem Ayub
C.E.O

NANBA

GROUP

www.nanbagroup.com

**LOOK
BOOK**

At NANBA we always strive our best to provide best customer services to our clients along with quality products and commitment over delivery. As a matter of fact, this catalogue is another milestone to make things more easy, practical, convincing and understanding for both our clientage and employees in manifold.

Big THANKS to everyone in the team as to compile this elegant & informative catalogue in the said filed.

We look forward for everyone's feedback on this catalouge so as to improve ourselves and make things easy for our auspicious business partners in coming edition.

CONTENTS

| | |
|--|---------|
| 1. Badges | 01-20 |
| 2. Aiguillettes & Shoulder Cords | 21-28 |
| 3. Lanyards & Whistle Cords, Snate Cords, Shoulder Cords | 29-38 |
| 4. Dress Cords, Flag Cords, Bugle Cords | 39-42 |
| 5. Tassels & Tassel Cords | 43-50 |
| 6. Fringes | 51-54 |
| 7. Cords | 55-58 |
| 8. Braids | 59-76 |
| 9. Swords & Sword Knots | 77-90 |
| 10. Medals, Ribbons, Bars, Rosettes | 91-104 |
| 11. Peak Caps & Shakos, Other Caps & Accessories | 105-126 |
| 12. Berets | 127-132 |
| 13. Shoulder, Epaulettes, Sliders | 133-150 |
| 14. Chevrons | 151-154 |
| 15. Gorgets | 155-158 |
| 16. Sashes | 159-160 |
| 17. Belts | 161-170 |
| 18. Leather Wallets | 171-176 |
| 19. Brassards, Arm Bands, Gaiters | 177-178 |
| 20. Neck ties, Bow Ties, Romals, Cummerbund | 179 |
| 20. Officer Canes, Batons & Pace Sticks | 180 |
| 21. Military, Police, Pilot, Tactical & Shooting Gloves | 181-192 |



Certified Company
ISO 9001-2015 & ISO 14001 - 2015

HANDMADE

Bullion

EMBROIDERED

ELEGANCE

NANABA

GROUP

www.nanabagroup.com



Bullion - Synopsis

The Hand Embroidered Badges! Are often called Blazer-badges, Bullion-badges, Emblems, and Insignias etc.

These comprise Pocket badges, Cap badges, Arm patches, Collar insignias, Family crests, Fashion badges, Bullion visors & peaks, Police badges, Military badges, Heraldic embroidered badges, Navy insignias, Ceremonial sashes embroidered, Wings, Pennants, Banners, Flags, Scout badges, Bullion embroidered pillows, Masonic badges, RAOB embroidered badges, rotary and club badges, War badges & Civil war bullion insignias etc.

These badges are mostly made off! Gold and silver bullion wires (Matt & Shine), gray/aluminum bullions Jaser-
ons, metal threads like Zeek and Tilla, cotton, polyester and silk threads.

However, we use guaranteed 100% un-faded material "Pak bullion", "French bullion", "standard bullion", "Half fine gold & silver bullion", "1% Gold plated bullion", "2% Gold plated bullion etc.

The shapes of the badges! Are usually rectangular, circular, oval, diameter, cut to shape and pocket-cut. However, all shapes are possible to make on request.



NG - 0786



NG - 0787



NG - 0788



NG - 0789



NG - 0790



NG - 0791

03



NG - 0792



NG - 0793



NG - 0794



NG - 0795



NG - 0796



NG - 0797



NG - 0798



NG - 0799



NG - 0800



NG - 0801



NG - 0802



NG - 0803



NG - 0804



NG - 0805



NG - 0806



NG - 0807



NG - 0808



NG - 0809



NG - 0810



NG - 0811

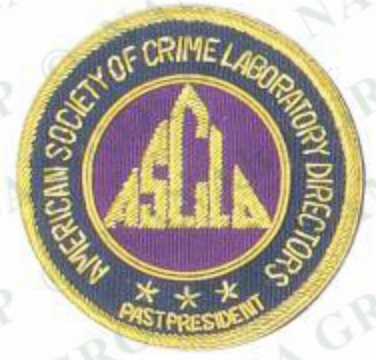

NG - 0812



NG - 0813



NG - 0814



NG - 0815

05



NG - 0816



NG - 0817



NG - 0818



NG - 0819



NG - 0820



NG - 0821



NG - 0822



NG - 0823



NG - 0824



NG - 0825



NG - 0826



NG - 0827



NG - 0828



NG - 0829



NG - 0830



NG - 0831



NG - 0832



NG - 0833



NG - 0834



NG - 0835



NG - 0836



NG - 0837



NG - 0838



NG - 0839



NG - 0840



NG - 0841



NG - 0842



NG - 0843



NG - 0844



NG - 0845



NG - 0846



NG - 0847



NG - 0848



NG - 0849



NG - 0850



NG - 0851

08



NG - 0852



NG - 0853



NG - 0854



NG - 0855



NG - 0856



NG - 0857



NG - 0858



NG - 0859



NG - 0860



NG - 0861



NG - 0862



NG - 0863



NG - 0864



NG - 0865



NG - 0866



NG - 0867



NG - 0868



NG - 0869



NG - 0870



NG - 0871



NG - 0872



NG - 0873



NG - 0874



NG - 0875

10



NG - 0876



NG - 0877



NG - 0878



NG - 0879



NG - 0880



NG - 0881



NG - 0882



NG - 0883



NG - 0884



NG - 0885



NG - 0886



NG - 0887



NG - 0888



NG - 0889



NG - 0890



NG - 0891



NG - 0892



NG - 0893



NG - 0894



NG - 0895



NG - 0896



NG - 0897



NG - 0898



NG - 0899



NG - 0900



NG - 0901



NG - 0902



NG - 0903



NG - 0904



NG - 0905



NG - 0906



NG - 0907



NG - 0908



NG - 0909



NG - 0910



(A)



(B)



(C)



(D)



(E)

NG - 0911



NG - 0912



NG - 0913



NG - 0914



NG - 0915



NG - 0916



NG - 0917



NG - 0918



NG - 0919



NG - 0920



NG - 0921



NG - 0922



NG - 0923



NG - 0924



NG - 0925



NG - 0926



NG - 0927



NG - 0928



NG - 0929



NG - 0930



NG - 0931



NG - 0932



NG - 0933



NG - 0934



NG - 0935



NG - 0936



NG - 0937

NANBA Being one Stop Place for
QUALITY CONSCIOUS
People That Care for Quality



MACHINE BADGES

We Use Best Quality Mylar Both Gold and Silver as well as Quality
Threads for our Machine Embroidered Products
Simply Astounding Quality with our Latest Machines

NANBA

GROUP

www.nanbagroup.com



NG - 1001

Quality: Mylar



NG - 1002

Quality: Mylar



NG - 1003

Quality: Thread



NG - 1004

Quality: Thread



NG - 1005

Quality: Thread



NG - 1006

Quality: Thread



NG - 1007

Quality: Thread

14

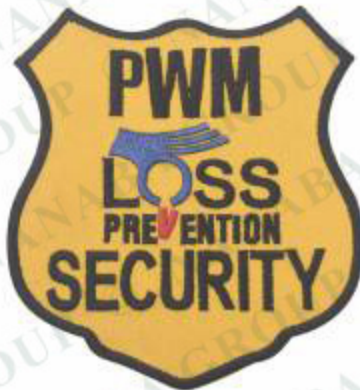

NG - 1008

Quality: Thread



NG - 1009

Quality: Thread



NG - 1010

Quality: Mylar & Thread



NG - 1011

Quality: Mylar



NG - 1012

Quality: Thread



NG - 1013

Quality: Mylar & Thread

Woven Products are Usually for
QUALITY CONSCIOUS
But for Mass productions



WOVEN BADGES

NANBA stands the best amongst its competitors in the range of woven products, we simply design the best to make the final product outstanding and marvelous

NANBA

GROUP

www.nanbagroup.com

Handmade Bullion Embroidery Work



NG - 1101



NG - 1102



NG - 1103



NG - 1104



NG - 1105



NG - 1106



NG - 1107



NG - 1108



NG - 1109



NG - 1110



NG - 1111



NG - 1112

Woven Badges

People Who are Habitually
QUALITY CONSCIOUS
Can Never Produce Mediocre Results.



METAL BADGES

NANBA stands up the best in making metal products for its auspicious clients. We use a range of materials, latest machines, quality gold & silver plating to give maximum finish to the artwork.

NANBA
GROUP

www.nanbagroup.com



NG - 1201



NG - 1202



NG - 1203



NG - 1204



NG - 1205



NG - 1206



NG - 1207



NG - 1208



NG - 1209



NG - 1210



NG - 1211



NG - 1212

Metal Badges

Good additions to the product &
QUALITY CONSCIOUS
organizations always create difference



RUBBER BADGES

NANBA rubber products are vastly used in manifold industries we supply to gloves industry, Aviation, Military, Airforce, Universities, Fire Departments Etc. Maximum Work Product.

NANBA

GROUP

www.nanbagroup.com



NG - 1301



NG - 1302



NG - 1303



NG - 1304



NG - 1305



NG - 1306



NG - 1307



NG - 1308



NG - 1309



NG - 1310



NG - 1311



NG - 1312

Uniform Aiguillettes & Shoulder Cords

Uniform Aiguillettes consist of two single plaits of aiguillette cord with two loops mainly. At the end of the plaits are approximately 3 inches of plain cord to which two gilt metal flag tags are secured. The metal flag tags are approximately 3½ inches long and mounted with anchors. Officials wear them on various uniforms for special or ceremonial occasions.

These are usually made in various materials such as Bullion, Wire, Mylar/Metallic Wire, Cotton, Silk, Polyester, Acrylic, Woolen Yarns etc, both in single color or tri colors, decorating with one tip, two tips, and three tips in various styles according to the needs of the clients both for male and female officials.

NANBA Manufactures a range of these military aiguillettes for its various clients worldwide in a quality i.e unmatched & unrivalled to any other competitor in the region both in material and craftsmanship.

Various Plaiting Options



Plaiting Type: 1
Bullion



Plaiting Type: 2
Wire



Plaiting Type: 3
Mylar/Metallic



Plaiting Type: 4
Wire & Silk



Plaiting Type: 5
Bullion





NANABA

GROUP

www.nanbagroup.com



NG - 1401

Material: Gold Wire French Light Color
Flag Tags: Gold Plated Highest Quality
Craftsmanship: Hand Plaited & Needle Stitched



NG - 1402

Material: Silver Wire
Flag Tags: Silver Plated Highest Quality
Craftsmanship: Hand Plaited & Needle Stitched



NG - 1403

Material: Full Cotton
Flag Tags: Gold Plated Highest Quality
Craftsmanship: Hand Plaited & Needle Stitched



NG - 1404

Material: Gold Wire With Silk Flecks
Flag Tags: Gold Plated Highest Quality
Craftsmanship: Hand Plaited & Needle Stitched



NG - 1405

Material: Gold Mylar With Silk Flecks
Flag Tags: Gold Plated Highest Quality
Craftsmanship: Hand Plaited & Needle Stitched



NG - 1406

Material: Silver Wire With Silk Flecks
Flag Tags: Silver Plated Highest Quality
Craftsmanship: Hand Plaited & Needle Stitched



NG - 1407

Material: Silver Mylar With Silk Flecks
Flag Tags: Silver Plaited Highest Quality
Craftsmanship: Hand Plaited & Needle Stitched



NG - 1408

Material: Silver Mylar/Metallic
Flag Tags: Silver Plaited Highest Quality
Craftsmanship: Hand Plaited & Needle Stitched



NG - 1409

Material: Silk Aiguillette With Silk Flecks
Flag Tags: Gold Plaited Highest Quality
Craftsmanship: Hand Plaited & Needle Stitched



NG - 1410

Material: Silver Wire With Silk Flecks
Flag Tags: Silver Plaited Highest Quality
Craftsmanship: Hand Plaited & Needle Stitched



NG - 1411

Material: Black Silk With White Flecks
Flag Tags: Silver Plaited Highest Quality
Craftsmanship: Hand Plaited & Needle Stitched



NG - 1412

Material: Navy Silk With Mylar Flecks
Flag Tags: Silver Plaited Highest Quality
Craftsmanship: Hand Plaited & Needle Stitched



NG - 1413

Material: Black Silk With Silver Mylar Flecks
Flag Tags: Silver Plaited Highest Quality
Craftsmanship: Hand Plaited & Needle Stitched



NG - 1414

Material: Gold Silk
Flag Tags: Gold Plaited Highest Quality
Craftsmanship: Hand Plaited & Needle Stitched



NG - 1415

Material: Bullion With Silk Flecks
Flag Tags: Silver Plaited Highest Quality
Craftsmanship: Hand Plaited & Needle Stitched



NG - 1416

Material: Silk Aiguillette With Silk Flecks
Flag Tags: Gold Plaited Highest Quality
Craftsmanship: Hand Plaited & Needle Stitched



NG - 1417

Material: Gold Wire With Silk Flecks
Flag Tags: Gold Plaited Highest Quality
Craftsmanship: Hand Plaited & Needle Stitched



NG - 1418

Material: Gold Wire Double Spindle
Flag Tags: Gold Plaited Highest Quality
Craftsmanship: Hand Plaited & Needle Stitched



NG - 1419

Material: Bullion German Style
Flag Tags: Silver Plated Highest Quality
Craftsmanship: Hand Plaited & Needle Stitched



NG - 1420

Material: Bullion German Style
Flag Tags: Gold Plated Highest Quality
Craftsmanship: Hand Plaited & Needle Stitched



NG - 1421

Material: White Cotton
Flag Tags: Silver Plated Highest Quality
Craftsmanship: Hand Plaited & Needle Stitched



NG - 1422

Material: Silver Wire With Red Silk Flecks
Flag Tags: Silver Plated Highest Quality
Craftsmanship: Hand Plaited & Needle Stitched



NG - 1423

Material: Gold & Red Silk
Flag Tags: Gold Plated Highest Quality
Craftsmanship: Hand Plaited & Needle Stitched



NG - 1424

Material: Gold Silk Double Spindle
Flag Tags: Gold Plated Highest Quality
Craftsmanship: Hand Plaited & Needle Stitched



NG - 1425

Material: Gold Wire Double Spindle
Flag Tags: Gold Plated Highest Quality
Craftsmanship: Hand Plaited & Needle Stitched



NG - 1426

Material: Silver Mylar
Flag Tags: Silver Plated Highest Quality
Craftsmanship: Hand Plaited & Needle Stitched



NG - 1427

Material: Green Silk
Flag Tags: Silver Plated Highest Quality
Craftsmanship: Hand Plaited & Needle Stitched



NG - 1428

Material: Gold Mylar With Silk Flecks
Flag Tags: Gold Plated Highest Quality
Craftsmanship: Hand Plaited & Needle Stitched



NG - 1429

Material: Silver Mylar
Flag Tags: Silver Plated Highest Quality 3 Tips
Craftsmanship: Hand Plaited & Needle Stitched



NG - 1430

Material: Gold Mylar
Flag Tags: Gold Plated Highest Quality 3 Tips
Craftsmanship: Hand Plaited & Needle Stitched



NG - 1431

Material: Gold Wire Double Spindle
Flag Tags: Gold Plaited
Craftsmanship: Hand Plaited



NG - 1432

Material: Silver German Mylar
Flag Tags: Silver Plaited
Craftsmanship: Hand Plaited



NG - 1433

Material: Gold Wire French
Flag Tags: Gold Plaited
Craftsmanship: Hand Plaited



NG - 1434

Material: Silver Wire
Flag Tags: Silver Plaited
Craftsmanship: Hand Plaited



NG - 1435

Material: Green Silk
Flag Tags: Gold Plaited
Craftsmanship: Hand Plaited



NG - 1436

Material: Gold Wire
Flag Tags: Gold Plaited
Craftsmanship: Hand Plaited



NG - 1437

Material: Gold Wire & Silk
Flag Tags: Gold Plaited
Craftsmanship: Hand Plaited



NG - 1438

Material: Silk Flecks
Flag Tags: Gold Plaited
Craftsmanship: Hand Plaited

AIGUILLETES & SHOULDER CORDS METAL TIPS, STAFF TAGS

NG - 1439



NG - 1440



NG - 1441



NG - 1442



NG - 1443



NG - 1444



NG - 1445



NG - 1446



Lanyards & Whistle Cords

Shoulder & Snate Cords



Perfect Match to...
YOUR UNIFORM

Various Plaiting Options



Plaiting Type: 1



Plaiting Type: 2



Plaiting Type: 3



Plaiting Type: 4

Materials: Silk, Polyester, Wire, Mylar/Mettalic, Cotton, Wool Etc.

Uniform • Cords



Plaiting Type: 5



Plaiting Type: 6

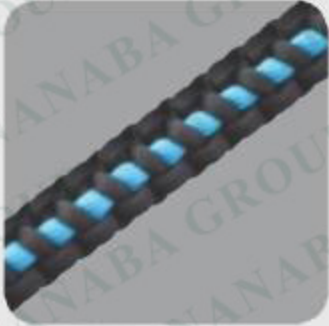

Plaiting Type: 7



Plaiting Type: 8



Plaiting Type: 9

The word 'Lanyard/Whistle Cord' itself is commonly used to describe a short rope to hold something, and can therefore be used to describe various items in use by the military. For instance a lanyard can be used to hold a whistle or identity etc. The practice of wearing lanyards, of various colours, on the right and left shoulder.

A shoulder cord is a military decoration which is worn on the shoulder. It may loop around the shoulder under the armpit, rest on the shoulder of the uniform, or attach to a point on the front of the uniform, depending on the design.

There are a number of different types of shoulder cords used by militaries all over the world, ranging from the blue infantry cord worn by American infantry soldiers to the Schützenschnur, an honor awarded by the German armed forces in recognition of marksmanship. A number of regulations govern the wearing of shoulder cords.

Materials: Silk, Polyester, Wool, Cotton, Wire, Mylar, French Mylar, Bullion etc.



NANBA

GROUP

www.nanbagroup.com



NG - 1501

Plaiting: Silk Or Polyester
Cord: Silk Or Polyester



NG - 1502

Plaiting: Silk Or Polyester
Cord: Silk Or Polyester



NG - 1503

Plaiting: Silk Or Polyester
Cord: Silk Or Polyester



NG - 1504

Plaiting: Silk Or Polyester
Cord: Silk Or Polyester



NG - 1505

Plaiting: Silk Or Polyester
Cord: Silk Or Polyester



NG - 1506

Plaiting: Wire Or Mylar
Cord: Wire Or Mylar



NG - 1507

Plaiting: Silk Or Polyester
Cord: Silk Or Polyester



NG - 1508

Plaiting: Silk Or Polyester
Cord: Silk Or Polyester



NG - 1509

Plaiting: Silk Or Polyester
Cord: Silk Or Polyester



NG - 1510

Plaiting: Silk Or Polyester
Cord: Silk Or Polyester



NG - 1511

Plaiting: Silk Or Polyester
Cord: Silk Or Polyester



NG - 1512

Plaiting: Silk Or Polyester
Cord: Silk Or Polyester



NG - 1513

Plaiting: Mylar & Silk Flecks
Cord: Mylar & Silk Flecks



NG - 1514

Plaiting: Mylar Material
Cord: Mylar & Silk Flecks



NG - 1515

Plaiting: Mylar & Silk Flecks
Cord: Mylar & Silk Flecks



NG - 1516

Plaiting: Silk Or Polyester
Cord: Silk Or Polyester



NG - 1517

Plaiting: Silk Or Polyester
Cord: Silk Or Polyester



NG - 1518

Plaiting: Silk Or Polyester
Cord: Silk Or Polyester



NG - 1519

Plaiting: Silk Or Polyester
Cord: Silk Or Polyester



NG - 1520

Plaiting: Cotton Material
Cord: Cotton Material



NG - 1521

Hook: Silver Or Gold
Cord: Silk Or Polyester



NG - 1522

Hook: Silver Or Gold
Cord: Silk Or Polyester



NG - 1523

Hook: Silver Or Gold
Cord: Silk Or Polyester



NG - 1524

Hook: Silver Or Gold
Cord: Silk Or Polyester



NG - 1525

Hook: Silver Or Gold
Cord: Silk Or Polyester



NG - 1526

Hook: Silver Or Gold
Cord: Silk Or Polyester



NG - 1527

Hook: Silver Or Gold
Cord: Silk Or Polyester



NG - 1528

Hook: Silver Or Gold
Cord: Silk Or Polyester



NG - 1529

Hook: Silver Or Gold
Cord: Silk Or Polyester



NG - 1530

Hook: Silver Or Gold
Cord: Silk Or Polyester



NG - 1531

Hook: Silver Or Gold
Cord: Silk Or Polyester



NG - 1532

Hook: Silver Or Gold
Cord: Silk Or Polyester



NG - 1533

Hook: Silver Or Gold
Cord: Silk Or Polyester



NG - 1534

Hook: Silver Or Gold
Cord: Silk Or Polyester



NG - 1535

Hook: Silver Or Gold
Cord: Silk Or Polyester



NG - 1536

Hook: Silver Or Gold
Cord: Silk Or Polyester



NG - 1537

Hook: Silver Or Gold
Cord: Silk Or Polyester



NG - 1538

Hook: Silver Or Gold
Cord: Silk Or Polyester



NG - 1539

Hook: Silver Or Gold
Cord: Silk Or Polyester



NG - 1540

Hook: Silver Or Gold
Cord: Silk Or Polyester



NG - 1541

Hook: Silver Or Gold
Cord: Silk Or Polyester



NG - 1542

Hook: Silver Or Gold
Cord: Mylar Or Wire



NG - 1543

Hook: Silver Or Gold
Cord: Silk Or Polyester



NG - 1544

Hook: Silver Or Gold
Cord: Silk Or Polyester



NG - 1545

Hook: Silver Or Gold
Cord: Silk Or Polyester



NG - 1546

Plaiting: Wire Or Mylar
End: Wire Or Mylar

NG - 1547

Plaiting: Wire Or Mylar
Hook/Tips: Gold Or Silver

NG - 1548

Plaiting: Silk Or Polyester
Hook: Gold Or Silver

NG - 1549

Plaiting: Silk Or Polyester
Knot: Silk Or Polyester

NG - 1550

Plaiting: Wire Material
Knot: Wire Material



NG - 1551

Tips: Silver Or Gold
Cord: Mylar Or Wire



NG - 1552

Hook: Silver Or Gold
Cord: Silk Or Polyester



NG - 1553

Knot: Silk Or Polyester
Cord: Silk Or Polyester



NG - 1554

Knot: Silk Or Polyester
Cord: Silk Or Polyester



NG - 1555

Knot: Silk Or Polyester
Cord: Silk Or Polyester



NG - 1556

Knot: Bullion & Mukaish
Cord: Bullion & Silk Flecks



NG - 1557

Knot: Bullion & Mukaish
Cord: Bullion & Silk Flecks



NG - 1558

Knot: Bullion & Mukaish
Cord: Bullion & Silk Flecks



NG - 1559

Knot: Bullion & Mukaish
Cord: Bullion & Silk Flecks



NG - 1560

Knot: Silk Or Polyester
Cord: Silk Or Polyester



NG - 1561

Plaiting: Handmade
Material: Silk Or Polyester



NG - 1562

Plaiting: Handmade
Material: Cotton



NG - 1563

Plaiting: Handmade
Material: Cotton



NG - 1564

Plaiting: Handmade
Material: Cotton



NG - 1565

Plaiting: Handmade
Material: Silk Or Polyester



NG - 1566

Plaiting: Handmade
Material: Silk Or Polyester



NG - 1567

Plaiting: Handmade
Material: Silk Or Polyester



NG - 1568

Plaiting: Handmade
Material: Silk Or Polyester



NG - 1569

Plaiting: Handmade
Material: Silk Or Polyester



NG - 1570

Plaiting: Handmade
Material: Silk Or Polyester



NG - 1571

Plaiting: Handmade
Material: Silk Or Polyester



NG - 1572

Plaiting: Handmade
Material: Wire



NG - 1573

Plaiting: Handmade
Material: Bullion



NG - 1574

Plaiting: Handmade
Material: Silk Or Polyester



NG - 1575

Plaiting: Handmade
Material: Silk Or Polyester



NG - 1576

Plaiting: Handmade
Material: Silk Or Polyester



NG - 1577

Plaiting: Handmade
Material: Silk Or Polyester



NG - 1578

Plaiting: Handmade
Material: Bullion



NG - 1579

Plaiting: Handmade
Material: Bullion



NG - 1580

Plaiting: Handmade
Material: Bullion

NANABA

GROUP

www.nanabagroup.com

DENOTING
CLASSINESS



NG - 1601

BUGLE
CORDS



NG - 1602

Think Quality, Think NANBA



NG - 1603



DRESS CORDS

NG - 1604

No Grass Stains
NO GLORY



FLAGS
& FLAG CORDS
ENRAPTURING QUALITY



PRECIOUS

NANBA

GROUP

www.nanbagroup.com



NG - 1701

Material: Silk



NG - 1702

Material: Silk



NG - 1703

Material: Silk



NG - 1704

Material: Silk



NG - 1705

Silk & Wool



NG - 1706

Material: Silk



NG - 1707

Material: Silk



NG - 1708

Material: Silk

Flag Cords



NG - 1801



TASSELS & CORDS TASSELS

QUALITY PRODUCTS

NANBA

GROUP

www.nanbagroup.com

Maximum
WORTH
PRODUCTS



NG - 1802





NG - 1803

Material: Bullion



NG - 1804

Material: Bullion



NG - 1805

Material: Bullion



NG - 1806

Material: Bullion



NG - 1807

Material: Bullion



NG - 1808

Material: Metallic



NG - 1809

Material: Bullion



NG - 1810

Material: Bullion



NG - 1811

Material: Metallic



NG - 1812

Material: Bullion



NG - 1813

Material: Bullion



NG - 1814

Material: Mylar



NG - 1815

Material: Mylar



NG - 1816

Material: Bullion



NG - 1817

Material: Bullion



NG - 1818
Material: Bullion



NG - 1819
Material: Bullion



NG - 1820
Material: Bullion



NG - 1821
Material: Bullion



NG - 1822
Material: Bullion



NG - 1823
Material: Bullion



NG - 1824
Material: Bullion



NG - 1825
Material: Cotton



NG - 1826
Material: Bullion



NG - 1827
Material: Bullion



NG - 1828
Material: Bullion



NG - 1829
Material: Bullion



NG - 1830
Material: Bullion



NG - 1831
Material: Bullion



NG - 1832
Material: Bullion

Tassels Range



NG - 1833

Bullion & Silk



NG - 1834

Mylar & Silk



NG - 1835

Bullion & Silk



NG - 1836

Bullion & Silk



NG - 1837

Material: Bullion



NG - 1838

Material: Bullion



NG - 1839

Material: Bullion



NG - 1840

Material: Silk



NG - 1841

Material: Silk



NG - 1842

Material: Silk



NG - 1843

Material: Mukaiish



NG - 1844

Material: Wira



NG - 1845

Wool & Silk



NG - 1846

Wool & Wool



NG - 1847

Wool & Wool



NG - 1848

Wool & Silk



NG - 1849

Material: Bullion



NG - 1850

Bullion & Bullion



NG - 1851

Bullion & Silk



NG - 1852

Material: Bullion



NG - 1853

Material: Bullion



NG - 1854

Material: Bullion



NG - 1855

Bullion & Silk



NG - 1856

Material: Silk



NG - 1857

Material: Mylar



NG - 1858

Material: Bullion



NG - 1859

Material: Bullion



NG - 1860

Mylar & Silk



NG - 1861

Mylar & Silk



NG - 1862

Material: Mylar



NG - 1863

Material: Bullion

Tassels Range

UNBEATABLE
QUALITY

Tassels Cords

NANBA

GROUP

www.nanbagroup.com



NG - 1864

Wire & Silk



NG - 1865

Wire & Silk



NG - 1866

Mylar & Silk



NG - 1867

Mukaish Wire & Silk



NG - 1868

Bullion & Wire



NG - 1869

Bullion & Silk



NG - 1870

Wire & Silk



NG - 1871

Mylar & Silk



NG - 1872

Bullion & Wire



NG - 1874

Wire & Silk



NG - 1873

Bullion & Wire



FRINGES

OUR BEST QUALITY

NANBA

GROUP

www.nanbagroup.com



NG - 1901



NG - 1902



NG - 1903



NG - 1904



NG - 1905



NG - 1906



NG - 1907



NG - 1908



NG - 1909



NG - 1910



NG - 1911



NG - 1912



NG - 1913



NG - 1914



NG - 1915



NG - 1916



NG - 1917



NG - 1918



NG - 1919



NG - 1920



NG - 1921



NG - 1922



NG - 1923



NG - 1924



NG - 1925



NG - 1926



NG - 1927



NG - 1928



NG - 1929



NG - 1930



NG - 1931



NG - 1932



NG - 1933



NG - 1934



NG - 1935



NG - 1936

Fringes

Heritage Luxury FASHION





CORDS

COLLECTION

NANBA

GROUP

www.nanbagroup.com





NG - 2021



NG - 2031



NG - 2022



NG - 2032



NG - 2023



NG - 2033



NG - 2024



NG - 2034



NG - 2025



NG - 2035



NG - 2026



NG - 2036



NG - 2027



NG - 2037



NG - 2028



NG - 2038



NG - 2029



NG - 2039



NG - 2030



NG - 2040



Fast braid...

- ◆ Machine made
- ◆ Computerized

Slow Braid...

- ◆ Handmade
- ◆ Khaddi Made

Jacquard Braid...

- ◆ Handmade
- ◆ Customized

NANABA

GROUP

www.nanbagroup.com

Braids

Uniform Braids are considered to be the most essential part of any final product accomplishment. These are infact videly used in various organizations such as Military, Navy, Air-force, Aviation, Ceremonial Uniforms, Fashion Industry, History Costumes and so on.

Nanba Group is one stop factory for all your **B**raids needs. We can make these braids in multiple designs & qualities. Available in range of materials i.e Wire, Mylar/Metallic, Silk, Cotton, Wool, Viscose Etc.

Let us know what you don't see here. We can Customize All.





NG - 2101



NG - 2102



NG - 2103



NG - 2104



NG - 2105



NG - 2106



NG - 2107



NG - 2108



NG - 2109



NG - 2110



NG - 2111



NG - 2112



NG - 2113

61



NG - 2114



NG - 2115



NG - 2116



NG - 2117



NG - 2118



NG - 2119



NG - 2120



NG - 2121



NG - 2122



NG - 2123



NG - 2124



NG - 2125



NG - 2126



NG - 2127



NG - 2128

Braids



NG - 2129



NG - 2130



NG - 2131



NG - 2132



NG - 2133



NG - 2134



NG - 2135



NG - 2136



NG - 2137



NG - 2138



NG - 2139



NG - 2140



NG - 2141



NG - 2142



NG - 2143



NG - 2144



NG - 2145



NG - 2146



NG - 2147



NG - 2148



NG - 2149



NG - 2150



NG - 2151



NG - 2152



NG - 2153



NG - 2154



NG - 2155



NG - 2156



NG - 2157



NG - 2158



NG - 2159



NG - 2160



NG - 2161



NG - 2162



NG - 2163



NG - 2164



NG - 2165



NG - 2166



NG - 2167



NG - 2168



NG - 2169



NG - 2170



NG - 2171



NG - 2172



NG - 2173



NG - 2174



NG - 2175



NG - 2176



NG - 2177



NG - 2178



NG - 2179



NG - 2180



NG - 2181



NG - 2182

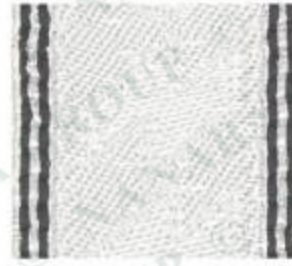

NG - 2183



NG - 2184



NG - 2185



NG - 2186



NG - 2187



NG - 2188



NG - 2189



NG - 2190

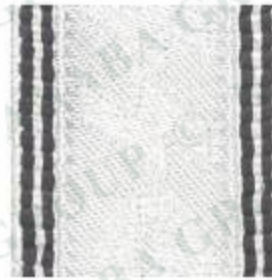

NG - 2191



NG - 2192



NG - 2193

64



NG - 2194



NG - 2195



NG - 2196



NG - 2197



NG - 2198



NG - 2199



NG - 2200



NG - 2201

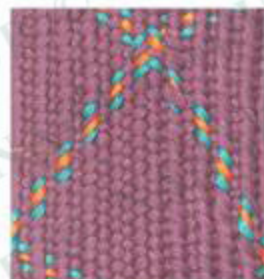

NG - 2202



NG - 2203



NG - 2204



NG - 2205

Braids



NG - 2206



NG - 2207



NG - 2208



NG - 2209



NG - 2210



NG - 2211



NG - 2212



NG - 2213



NG - 2214



NG - 2215

65



NG - 2216



NG - 2217



NG - 2218



NG - 2219



NG - 2220



NG - 2221



NG - 2222



NG - 2223



NG - 2224



NG - 2225



NG - 2226



NG - 2227



NG - 2228



NG - 2229



NG - 2230



NG - 2231

Braids



NG - 2232



NG - 2233



NG - 2234



NG - 2235



NG - 2236



NG - 2237



NG - 2238



NG - 2239



NG - 2240



NG - 2241



NG - 2242



NG - 2243



NG - 2244



NG - 2245



NG - 2246



NG - 2247



NG - 2248



NG - 2249



NG - 2250



NG - 2251



NG - 2252



NG - 2253



NG - 2254



NG - 2255



NG - 2256



NG - 2257



NG - 2258



NG - 2259



NG - 2260



NG - 2261

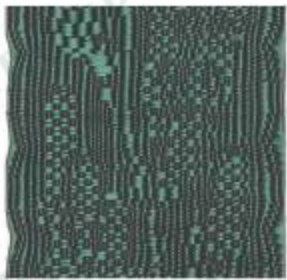

NG - 2262



NG - 2263



NG - 2264



NG - 2265



NG - 2266



NG - 2267



NG - 2268



NG - 2269



NG - 2270



NG - 2271



NG - 2272



NG - 2273



NG - 2274



NG - 2275



NG - 2276



NG - 2277



NG - 2278



NG - 2279



NG - 2280



NG - 2281



NG - 2282

67



NG - 2283



NG - 2284



NG - 2285



NG - 2286



NG - 2287



NG - 2288



NG - 2289



NG - 2290



NG - 2291



NG - 2292



NG - 2293



NG - 2294



NG - 2295



NG - 2296



NG - 2297



NG - 2298



NG - 2299



NG - 2300



NG - 2301



NG - 2302



NG - 2303



NG - 2304



NG - 2305



NG - 2306



NG - 2307



NG - 2308

Braids

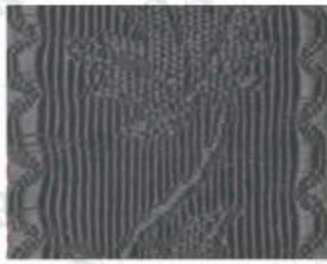

NG - 2309



NG - 2310



NG - 2311



NG - 2312



NG - 2313



NG - 2314



NG - 2315



NG - 2316



NG - 2317



NG - 2318



NG - 2319



NG - 2320



NG - 2321



NG - 2322



NG - 2323



NG - 2324



NG - 2325



NG - 2326



NG - 2327



NG - 2328



NG - 2329



NG - 2330



NG - 2331



NG - 2332



NG - 2333



NG - 2334



NG - 2335

Braids



NG - 2336



NG - 2337



NG - 2338



NG - 2339



NG - 2340



NG - 2341



NG - 2342



NG - 2343



NG - 2344

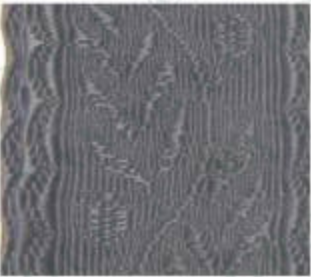

NG - 2345



NG - 2346



NG - 2347



NG - 2348



NG - 2349

70



NG - 2350



NG - 2351



NG - 2352



NG - 2353



NG - 2354



NG - 2355



NG - 2356



NG - 2357

Braids



NG - 2358



NG - 2359



NG - 2360



NG - 2361



NG - 2362



NG - 2363



NG - 2364



NG - 2365



NG - 2366



NG - 2367



NG - 2368



2369



2370



2371



2372



2373



NG - 2374



2375



2376



2377



2378



NG - 2379



2380



2381



2382



2383



2384



2385



2386



2387



2388



NG - 2389



2390



2391



NG - 2392



2393



2394



2395



2396



2397



2398

Braids

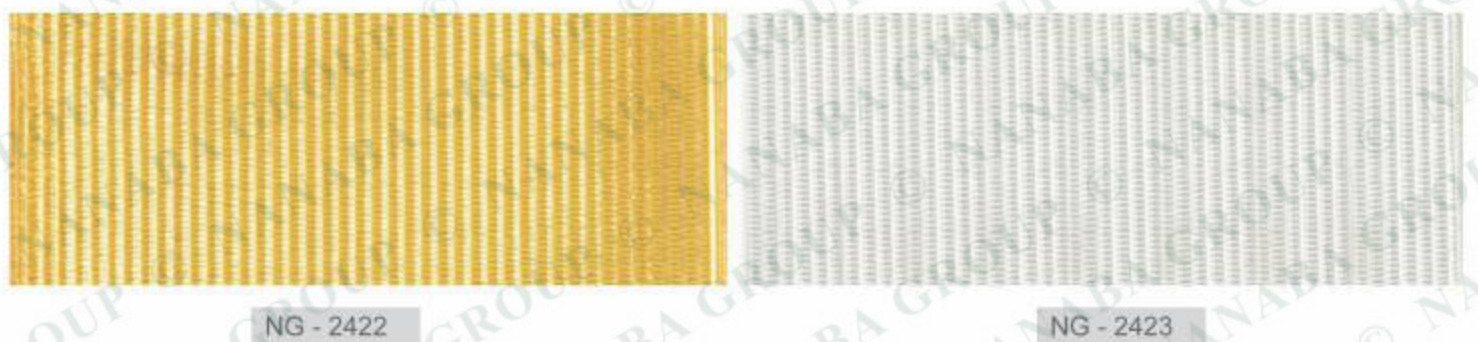
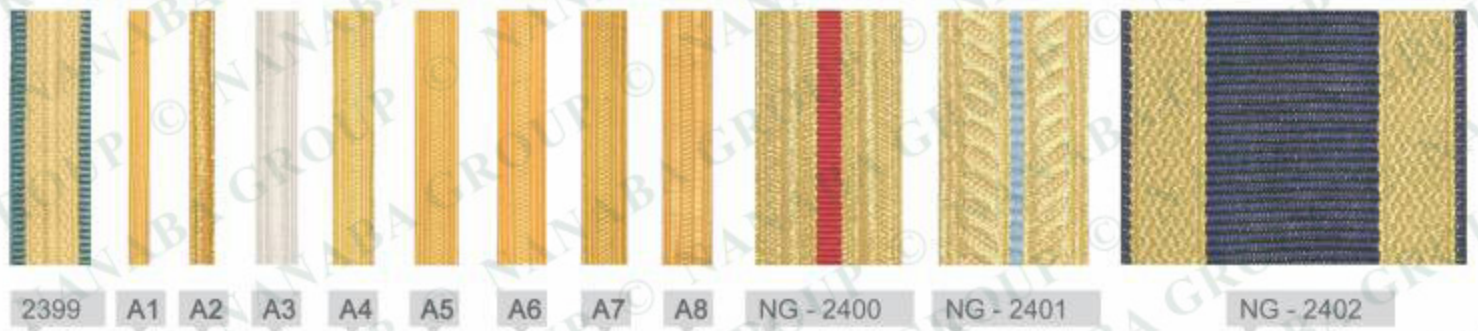

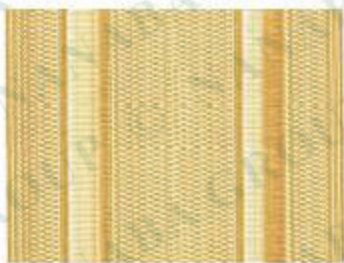

NG - 2424

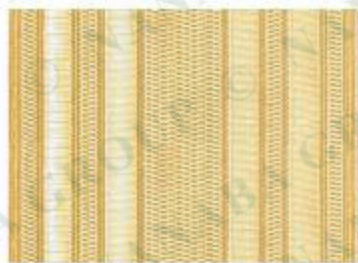

NG - 2425



NG - 2426



NG - 2427



NG - 2428



NG - 2429



NG - 2430



NG - 2431

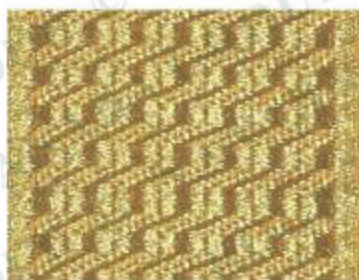

NG - 2432



NG - 2433



NG - 2434



NG - 2435



NG - 2436



NG - 2437



NG - 2438



NG - 2439



NG - 2440



NG - 2441



NG - 2442

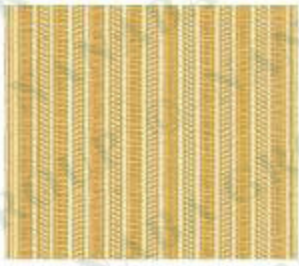

NG - 2443



NG - 2444



NG - 2445



NG - 2446



NG - 2447



NG - 2448



NG - 2449



NG - 2450



NG - 2451



NG - 2452



NG - 2453



NG - 2454



NG - 2455



NG - 2456



NG - 2457



2458



2459



2460



2461



2462



2463



2464



2465



2466



2467



2468



2469



2470

74



NG - 2471



NG - 2472



NG - 2473



NG - 2474



NG - 2475



NG - 2476



NG - 2477



NG - 2478



NG - 2479



NG - 2480



NG - 2481



NG - 2482



NG - 2483



NG - 2484



NG - 2485



NG - 2486

Since 1992

Bespoke



0 1 2 3 4 5 6 7 8 9 10 11 12 13 14 15 16 17 18 19

Size to Original



NG - 2487



NG - 2488



2489



2490



NG - 2491



2492



NG - 2493



NG - 2494



NG - 2495



NG - 2496



NG - 2497



NG - 2498



NG - 2499



NG - 2500

Braids



NG - 2501



2502



2503



2504



2505



2506



2507



2508

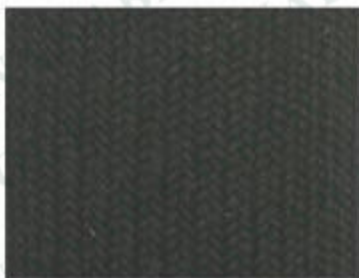

NG - 2509



NG - 2510



NG - 2511



NG - 2512



NG - 2513

Braids

SWORDS

Swords are perhaps considered to be the more reflective, representative and allegorical, conveying much more meaning than what to be appear on the surface level, It shows organizational spirit & uplifted hierarchy.

NANBA has won many official supplies due to the vast experience in the said field. We understand your requirements whether you are a serving military member or an astute military collector, your demand of unrivalled quality and the finest workmanship in collectables and memorabilia is to be found with us.

NANBA offers military dress sabers and military swords manufactured according to exact government specifications. We have proudly supplied military officer's swords and sabers for the worldwide clients. We simply deliver the very best.

We also offer custom engraving on dress swords & sabers since we customized all. We ship worldwide proudly to be the best amongst its competitors.

Think Quality, Think NANBA !





NANABA

GROUP

www.nanbagroup.com



NG - 2601

- Material Specifications:
- Sword Blade: Steel, Iron
 - Handles: Brass, Puter
 - Sizes: All Sizes are Available
 - Scabbard Fittings: Brass, Puter
 - Plating: Gold, Silver, Antiquesation
 - BeSpoke: We do Customization
 - Scabbard: Steel, Leather, Rexine, Wood
 - Workmanship: Mahcine, Handwork
 - Print: Engraving with Eatching



NG - 2602

- Material Specifications:
- Sword Blade: Steel, Iron
 - Handles: Brass, Puter
 - Sizes: All Sizes are Available
 - Scabbard Fittings: Brass, Puter
 - Plating: Gold, Silver, Antiquesation
 - BeSpoke: We do Customization
 - Scabbard: Steel, Leather, Rexine, Wood
 - Workmanship: Mahcine, Handwork
 - Print: Engraving with Eatching



NG - 2603

- Material Specifications:
- Sword Blade: Steel, Iron
 - Handles: Brass, Puter
 - Sizes: All Sizes are Available
 - Scabbard Fittings: Brass, Puter
 - Plating: Gold, Silver, Antiquesation
 - BeSpoke: We do Customization
 - Scabbard: Steel, Leather, Rexine, Wood
 - Workmanship: Mahcine, Handwork
 - Print: Engraving with Eatching



NG - 2604

- Material Specifications:**
- Sword Blade: Steel, Iron
 - Scabbard Fittings: Brass, Puter
 - Scabbard: Steel, Leather, Rexine, Wood
 - Handles: Brass, Puter
 - Plating: Gold, Silver, Antiquesation
 - Workmanship: Mahcine, Handwork
 - Sizes: All Sizes are Available
 - BeSpoke: We do Customization
 - Print: Engraving with Eatching



NG - 2605

- Material Specifications:**
- Sword Blade: Steel, Iron
 - Scabbard Fittings: Brass, Puter
 - Scabbard: Steel, Leather, Rexine, Wood
 - Handles: Brass, Puter
 - Plating: Gold, Silver, Antiquesation
 - Workmanship: Mahcine, Handwork
 - Sizes: All Sizes are Available
 - BeSpoke: We do Customization
 - Print: Engraving with Eatching



NG - 2606

- Material Specifications:**
- Sword Blade: Steel, Iron
 - Scabbard Fittings: Brass, Puter
 - Scabbard: Steel, Leather, Rexine, Wood
 - Handles: Brass, Puter
 - Plating: Gold, Silver, Antiquesation
 - Workmanship: Mahcine, Handwork
 - Sizes: All Sizes are Available
 - BeSpoke: We do Customization
 - Print: Engraving with Eatching



NG - 2607

- Material Specifications:
- Sword Blade: Steel, Iron
 - Handles: Brass, Puter
 - Sizes: All Sizes are Available
 - Scabbard Fittings: Brass, Puter
 - Plating: Gold, Silver, Antiquesation
 - BeSpoke: We do Customization
 - Scabbard: Steel, Leather, Rexine, Wood
 - Workmanship: Mahcine, Handwork
 - Print: Engraving with Eatching



NG - 2608

- Material Specifications:
- Sword Blade: Steel, Iron
 - Handles: Brass, Puter
 - Sizes: All Sizes are Available
 - Scabbard Fittings: Brass, Puter
 - Plating: Gold, Silver, Antiquesation
 - BeSpoke: We do Customization
 - Scabbard: Steel, Leather, Rexine, Wood
 - Workmanship: Mahcine, Handwork
 - Print: Engraving with Eatching



NG - 2609

- Material Specifications:
- Sword Blade: Steel, Iron
 - Handles: Brass, Puter
 - Sizes: All Sizes are Available
 - Scabbard Fittings: Brass, Puter
 - Plating: Gold, Silver, Antiquesation
 - BeSpoke: We do Customization
 - Scabbard: Steel, Leather, Rexine, Wood
 - Workmanship: Mahcine, Handwork
 - Print: Engraving with Eatching



NG - 2610

- Material Specifications:**
- Sword Blade: Steel, Iron
 - Scabbard Fittings: Brass, Puter
 - Scabbard: Steel, Leather, Rexine, Wood
 - Handles: Brass, Puter
 - Plating: Gold, Silver, Antiquesation
 - Workmanship: Mahcine, Handwork
 - Sizes: All Sizes are Available
 - BeSpoke: We do Customization
 - Print: Engraving with Eatching



NG - 2611

- Material Specifications:**
- Sword Blade: Steel, Iron
 - Scabbard Fittings: Brass, Puter
 - Scabbard: Steel, Leather, Rexine, Wood
 - Handles: Brass, Puter
 - Plating: Gold, Silver, Antiquesation
 - Workmanship: Mahcine, Handwork
 - Sizes: All Sizes are Available
 - BeSpoke: We do Customization
 - Print: Engraving with Eatching



NG - 2612

- Material Specifications:**
- Sword Blade: Steel, Iron
 - Scabbard Fittings: Brass, Puter
 - Scabbard: Steel, Leather, Rexine, Wood
 - Handles: Brass, Puter
 - Plating: Gold, Silver, Antiquesation
 - Workmanship: Mahcine, Handwork
 - Sizes: All Sizes are Available
 - BeSpoke: We do Customization
 - Print: Engraving with Eatching

Sword KNOTS

Good Quality

Our Commitment is always Focused to Develop Quality Product Using best Available Materials.



Perfect Fit

Our Made Sword Knot is a Perfect Companion to your Sword, Winning the Elegance...



Craftsmanship

Our Skilled Workmen are at their best when making a Sword Knot Simply Enrapturing.



Think Quality
Think NANBA...

elegance & PRIDE



NANABA

GROUP

www.nanbagroup.com



NG - 2701

Knot: Wire
Strap: Leather



NG - 2702

Knot: Wire & Silk
Strap: Leather



NG - 2703

Knot: Wire
Strap: Leather



NG - 2704

Knot: Wire
Strap: Mylar & Silk



NG - 2705

Knot: Wire
Strap: Silk



NG - 2706

Knot: Wire
Strap: Wire



NG - 2707

Knot: Wire
Strap: Mylar & Silk



NG - 2708

Knot: Wire
Strap: Mylar & Silk



NG - 2709

Knot: Wire
Strap: Silk



NG - 2710

Knot: Wire
Strap: Mylar & Silk



NG - 2711

Knot: Wire
Strap: Silk



NG - 2712

Knot: Wire
Strap: Leather



NG - 2713

Knot: Bullion
Strap: Mylar & Silk



NG - 2714

Knot: Silk
Strap: Viscose



NG - 2715

Knot: Wire
Strap: Wire



NG - 2716

Knot: Silk
Strap: Silk



NG - 2717

Knot: Wire
Strap: Silk



NG - 2718

Knot: Wire
Strap: Mylar & Silk



NG - 2719

Knot: Bullion
Strap: Bullion



NG - 2720

Knot: Bullion
Strap: Silk



NG - 2721

Knot: Bullion
Strap: Bullion



NG - 2722

Knot: Bullion
Strap: Mylar



NG - 2723

Knot: Bullion
Strap: Bullion



NG - 2724

Knot: Bullion
Strap: Wire



NG - 2725

Knot: Wire
Strap: Wire & Silk



NG - 2726

Knot: Wire
Strap: Mylar & Silk



NG - 2727

Knot: Wire
Strap: Wire & Silk



NG - 2728

Knot: Wire
Strap: Wire & Silk



NG - 2729

Knot: Wire
Strap: Slik & Mylar



NG - 2730

Knot: Wire
Strap: Slik & Mylar



NG - 2731

Knot: Wire
Strap: Wire



NG - 2732

Knot: Wire & Silk
Strap: Wire & Silk



NG - 2733

Knot: Wire & Silk
Strap: Wire & Silk



NG - 2734

Knot: Wire & Silk
Strap: Wire



NG - 2735

Knot: Wire & Silk
Strap: Mylar & Silk



NG - 2736

Knot: Leather
Strap: Leather



NG - 2737

Knot: Leather
Strap: Leather



NG - 2738

Knot: Leather
Strap: Leather



NG - 2739

Knot: Leather
Strap: Leather



NG - 2740

Knot: Leather
Strap: Leather



NG - 2741

Knot: Wire
Strap: Wire



NG - 2742

Knot: Wire
Strap: Wire



NG - 2743

Knot: Wire
Strap: Wire



NG - 2744

Knot: Wire
Strap: Wire



NG - 2745

Knot: Wire & Silk
Strap: Wire & Silk



NG - 2746

Knot: Wire & Silk
Strap: Wire & Silk



NG - 2747

Knot: Wire & Silk
Strap: Wire & Silk



NG - 2748

Knot: Wool
Strap: Wool



NG - 2749

Knot: Wool
Strap: Wool



NG - 2750

Knot: Bullion
Strap: Mylar



NG - 2751

Knot: Bullion
Strap: Wire



NG - 2752

Knot: Bullion
Strap: Wire



NG - 2753

Knot: Bullion
Strap: Silk & Mylar



NG - 2754

Knot: Bullion
Strap: Silk & Mylar



NG - 2755

Knot: Wire
Strap: Wire



NG - 2756

Knot: Wire
Strap: Wire

Swords & Sword Knots

Quality PREVAILS



NANBA

GROUP

www.nanbagroup.com





UnMatched
Quality
DETAILS

Think Quality
Think NANBA

NANBA

GROUP

www.nanbagroup.com

MEDALS
ROSETTES
BARS/DEXMUDE
PINS
SASHES



M E D A L
RIBBONS

Dexmude with
eXecutive
Metal
Solutions

Artistry to Remakeable Finish





NG - 2801 - Sash with Jewel Regalia

Material: Bullion Aiguillette German Style
Flag Tags: Silver Plated Highest Quality
Craftsmanship: Hand Plaited & Needle Stitched



NG - 2802 - Valor Chest/Breast Star Jewel Emblem

Material: Bullion Aiguillette German Style
Flag Tags: Silver Plated Highest Quality
Craftsmanship: Hand Plaited & Needle Stitched



(Folded View)



28mm Rosette
Brass



NG - 2803 - Token Signet Ribbon

Material: Bullion Aiguillette German Style
Flag Tags: Silver Plated Highest Quality
Craftsmanship: Hand Plaited & Needle Stitched

[Production Click](#)

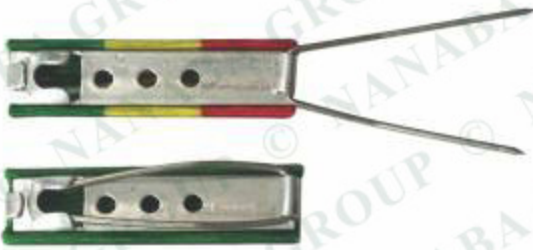

NG - 2804 - Dexmude/Medal Bars

Material: Bullion Aiguillette German Style
Flag Tags: Silver Plated Highest Quality
Craftsmanship: Hand Plaited & Needle Stitched



NG - 2805 - Customize Box

Material: Bullion Aiguillette German Style
Flag Tags: Silver Plaited Highest Quality
Craftsmanship: Hand Plaited & Needle Stitched



NG - 2806 - Companion Set: Gran Cruz

Material: Bullion Aiguillette German Style
Flag Tags: Silver Plaited Highest Quality
Craftsmanship: Hand Plaited & Needle Stitched



NG - 2807 - Companion Set Official

Material: Bullion Aiguillette German Style
Flag Tags: Silver Plaited Highest Quality
Craftsmanship: Hand Plaited & Needle Stitched



NG - 2808 - Companion Set Caballero

Material: Bullion Aiguillette German Style
Flag Tags: Silver Plaited Highest Quality
Craftsmanship: Hand Plaited & Needle Stitched



NG - 2809 - Service Medal

Material: Bullion Aiguillette German Style
Flag Tags: Silver Plaited Highest Quality
Craftsmanship: Hand Plaited & Needle Stitched



NG - 2810 - Medal Honor Award with Jewel

Material: Bullion Aiguillette German Style
Flag Tags: Silver Plaited Highest Quality
Craftsmanship: Hand Plaited & Needle Stitched



NG - 2811 - Dexmude/Medal Bars

Material: Bullion Aiguillette German Style
Flag Tags: Silver Plaited Highest Quality
Craftsmanship: Hand Plaited & Needle Stitched



NG - 2812 - Medal Honor Award with Jewel

Material: Bullion Aiguillette German Style
Flag Tags: Silver Plaited Highest Quality
Craftsmanship: Hand Plaited & Needle Stitched



NG - 2813 - Rosette with Butterfly Pin

Material: Bullion Aiguillette German Style
Flag Tags: Silver Plaited Highest Quality
Craftsmanship: Hand Plaited & Needle Stitched



6mm Gold Wire Braid



6mm Silver Wire Braid



| | | | | | |
|--|--|---|--|---|---|
|  01 - Air Force Commendation |  02 - Air Medal |  03 - Air Medal |  04 - American Campaign Medal |  05 - American Campaign Medal |  06 - American Defence Medal |
|  07 - American Defence Medal |  08 - Army Commendation |  09 - Army Commendation |  10 - Army Good Conduct |  11 - Army of Cuba Occupation |  12 - Army of Cuba Occupation |
|  13 - China Relief Campaign |  14 C.G. Lifesaving Gold |  15 Cuban Pacification |  16 - Distinguished Service Cross Army |  17 - Distinguished Service Medal Navy/MC |  18 - Distinguished Service Medal Navy/MC |

CIVILIAN ORGANIZATION ROSETTE

| | | | | | |
|--|---|--|---|--|--|
|  19 - American Legion |  20 - American Legion |  21 - American Legion |  22 - American Legion |  23 Military Order of The World Wars |  24 Military Order of The World Wars |
|  25 Naval Order of The U.S. |  26 Naval Order of The U.S. |  27 Naval Order of The U.S. |  28 O/O Founders & Patriots of America |  29 Princeton University |  30 Reserve Officers Association BH |
|  31 Reserve Officers Association CB |  32 Society American Military Engineers |  33 Sons of the American Revolution |  34 Sons of Union Veterans of the Civil War |  35 St. Georges' Society |  36 The Retired Officers Assn. Awd. |
|  37 United Way's Tocqueville Society |  38 Veterans of Foreign Wars |  39 Assn. Military Surgeons |  40 American Legion 9mm |  41 - American Legion 10mm |  42 - American Legion Other |
|  43 - American Legion Silver wire |  44 - American Legion Gold wire |  45 - Association of Military Surgeons of the US |  46 General Society War of 1812 CB |  47 General Society War of 1812 |  48 Huguenot Society |

| | | | | | |
|---|--|---|---|---|---|
|  49 - Military O/O Loyal Legion Member |  50 - Military Order of The World Wars 9mm |  51 - Military Order of The World Wars 10mm |  52 - Naval Order of the U.S. 9mm |  53 - Naval Order of the U.S. 10mm |  54 - Naval Order of the U.S. 12mm |
|  55 -O/O Founders & Patriots of America |  56 - Perinceton University |  57 - Reserve Officers Association CB |  58 - Reserve Officers Association |  59 - Society American Military Engineers |  60 - Sons of the American Revolution |
|  61 -Sons of the Republic of Texas |  62 -Sons of the Union Veterans of the Civil War |  63 -St. Georges' Society |  64 -The Retired Officers Association |  65 -United Way's Tocqueville Society |  66 -Veterans of Foreign Wars |

FOREIGN ROSETTES

| | | | | | |
|---|---|--|--|---|--|
|  67 -Austria Decoration for service |  68 -Belgium Assn.-Barbant Order of Merit |  69 -Belgium Comm. Medal 1914 - 18 War |  70 -Belgium Civil Decoration for Long Service |  71 -Belgium Cross of Fire- (1914-18) |  72 -Belgium Croxic de Guerre W.W.I |
|  73 -Belgium Croxic de Guerre W.W. II |  74 -Belgium Military Decoration |  75 -Belgium O/O Leopold I |  76 -Belgium O/O Leopold II |  77 -Belgium O/O Crown |  78 -Bulgaria National O/O Civil Merit |
|  79 -Italy Italian - Austrian War - 1915-18 |  80 -Italy O/O Crown |  81 -Italy O/O Crown |  82 -Italy O/O Crown |  83 -Italy O/O Merit Grand Officer |  84 -Italy SS. Maurice and Lazarus |
|  85 -Italy SS. Maurice and Lazarus |  86 -Italy War Cross |  87 -Japan O/O the Sacred Treasure 6 Class |  88 -Japan O/O the Rising Sun 8 Class |  89 -Loas O/O tje Million Elephants |  90 -Luxembourg Adolphe de Nassau |
|  91 -Netherlands O/O Orange-O/O St John |  92 -Netherlands Order of Orange- |  93 -Netherlands O/O Orange Nassau |  94 -Poland O/O Polonia Restitua (GC) |  95 -Portugal O/O Tower & Sword |  96 -Portugal O/O Tower & Sword |

| | | | | | |
|---|--|--|---|---|---|
|  97 -Thailand O/O White Elephant |  98 -Tunisia Military Medal |  99 -Tunisia Nichan Iftikhar |  100 -Tunisia Nichan Iftikhar |  101 -U.K 1914-16 Star |  102 -U.K 1914-16 Star |
|  103 -U.K 1914-16 Star |  104 -U.K Distinguished Service Cross |  105 -U.K Distinguished Service Order |  106 -U.K Military Cross |  107 -U.K Military Cross |  108 -U.K Military Medal |
|  109 -U.K War Medal 1914-20 |  110-Belgium O/O Leopold I |  111 -Belgium O/O Leopold II |  112 -Belgium O/O Leopold II |  113 -Belgium O/O Crown |  114 -Italy War Cross |
|  115 -Colombia O/O Cross of Boyaca |  116 -Colombia O/O Cross of Boyaca |  117 -Colombia O/O Cross of Boyaca |  118 -Dominican Republic O/O Christopher Columbus |  119 -Dominican Republic O/O Christopher Columbus |  120 -Dominican Republic O/O Christopher Columbus |
|  121 -Dominican Republic O/O Military merit |  122 -Dominican Republic O/O Military merit |  123 -Guatemala O/O Irisarri |  124 -Panama O/O Manuel Amador Guerrero |  125 -Panama O/O Vasco Nunez de Balboa |  126 -Peru O/O Sun of Peru |
|  127 -Peru O/O Sun of Peru |  128 -Peru O/O Sun of Peru |  129 -Peru O/O Distinguished Service |  130 -Peru O/O Distinguished Service |  131 -Venezuela Almirante Brion Naval Medal |  132 -Venezuela Armed Forces Cross of Cooperation |
|  133 -Venezuela Brigida Iriaate Order 2nd Class |  134 -Venezuela Medal 27th June 3rd Class |  135 -Venezuela Naval Order of Merit 1st Class |  136 -Venezuela O/O Francisco De Miranda 1st C |  137 -Venezuela O/O Francisco De Miranda 2nd C |  138 -Venezuela O/O Francisco De Miranda 3rd C |
|  139 -Venezuela O/O Miranda/ O/O Paez 20yr. |  140 -Venezuela O/O Liberator |  141 -Venezuela O/O Liberator |  142 -Venezuela O/O Liberator |  143 -Venezuela O/O Liberator |  144 -Venezuela O/O Liberator |
|  145 -Distinguished Service Medal Navy/MC |  146 European-African Middle Eastern Cpn |  147 European-African Middle Eastern Cpn |  148 -Philippinan Campaign |  149 Haitian Comaign Medal |  150 Haitian Comaign Medal |

| | | | | | |
|--|--|---|--|---|--|
|  151 -Ethiopia O/O Star of Ethiopia |  152 France Association Society/Industry Commerce |  153 -France French Family Medal |  154 -France Legion Honor |  155 -France Medal for Indochina 1953 |  156 -France O/O Black Star of Benin |
|  157 France Assn. Attorneys |  158 France Assn. Cycling Merit |  159 France Assn. Medal of Civil Education |  160 France Assn. Franco-British friendship |  161 France Assn. Honey Be |  162 France Assn. Medal of Honor Vol. Service |
|  163 France Assn. Medal of Honor Social Education |  164 France Assn. National Dept. of Academics |  165 France Masons |  166 France Musician |  167 France Pharmacists |  168 France Miners |
|  169 France Physicians |  170 France "Stars" |  171 France "Letter U" |  172 France Comm. Medal War- (1914-18) |  173 France Comm. Medal War- (1914-18) |  174 France Croix de Guerre-W.W.I |
|  175 France Croix de Guerre-W.W.2 |  176 France Croix de Guerre-W.W.2 |  177 France Famille Francaise |  178 France Legion of Honor |  179 France Legion of Honor |  180 France Legion of Honor BH |
|  181 -France Legion of Honor CB |  182 -France Legion of Honor CDG-W.W. I/II |  183 -France Medal Militaire |  184 -France Medal Militaire |  185 -France Medal Militaire |  186 -France Medal Militaire |
|  187 -France O/O Agricultural Merit |  188 -France O/O Agricultural Merit w/LoH |  189 -France O/O Art and Letters |  190 -France O/O Black Star of Benin |  191 -France O/O Merit |  192 -France O/O Public Health |
|  193 -Presidential Medal for Merit |  194 -France O/O Social Merit |  195 -France O/O Social Merit |  196 -France Plumes Academies |  197 -France Plumes Academies |  198 -France Plumes Academies |
|  199 -France Plumes Academies |  200 -France Plumes Academies |  201 -France Plumes Academies w/LoH-OoAM |  202 -France Resistance Medal |  203 -France Assn. Unknown |  204 NASA Exceptional Bravery Medal |

NANBA

GROUP

www.nanbagroup.com

We Provide

RIBBONS to the WORLD

MEDAL & REGALIA
MANUFACTURERS



NG - 2901

NG - 2902

NG - 2903



NG - 2904
Moire

NG - 2905
Moire

NG - 2906
Diamond



NG - 2907
Moire

NG - 2908
Plain

NG - 2909
Plain

Viscose
QUALITY
Both
PLAIN & MOIRE



NG - 2910



NG - 2911



NG - 2912



NG - 2913



NG - 2914



NG - 2915



NG - 2916



NG - 2917



NG - 2918



NG - 2919



NG - 2920



NG - 2921



NG - 2922



NG - 2923



NG - 2924



NG - 2925



NG - 2926



NG - 2927



NG - 2928



NG - 2929



NG - 2930



NG - 2931



NG - 2932



NG - 2933



NG - 2934



NG - 2935



NG - 2936



NG - 2937



NG - 2938



NG - 2939

Medal Ribbons



NG - 2940



NG - 2941



NG - 2942



NG - 2943



NG - 2944



NG - 2945



NG - 2946



NG - 2947



NG - 2948



NG - 2949



NG - 2950



NG - 2951



NG - 2952



NG - 2953



NG - 2954



NG - 2955



NG - 2956



NG - 2957



NG - 2958



NG - 2959



NG - 2960



NG - 2961



NG - 2962



NG - 2963



NG - 2964



NG - 2965



NG - 2966



NG - 2967



NG - 2968



NG - 2969



NG - 2970



NG - 2971



NG - 2972



NG - 2973



NG - 2974



NG - 2975



NG - 2976



NG - 2977



NG - 2978



NG - 2979



NG - 2980



NG - 2981



NG - 2982



NG - 2983



NG - 2984



NG - 2985



NG - 2986



NG - 2987



NG - 2988



NG - 2989



NG - 2990



Chin Strap

- Gold & Silver Mylar
- Gold & Silver Wire
- PU, PVC Material
- Embroidery Chin Strap
- Chin Cord



External Band

- Available Embroidered or Plain
- Blazer
- Velvet
- Ribbon
- Jacquard Ribbon
- Mohair Braid
- UK Handsworth Wool



Button

- Brass & Alloy Materials
- Gold Plated
- Silver Plated (Nickel, Chrome)
- We do Customized Button
- Available All Sizes



Cap Badge

- Hand Embroidery Badge
- Machine Embroidery Badge
- Woven Badge
- Matel Badge



Peak Embroidery

- Golden & Silver Bullion Wire
- Golden & Silver Mylar Thread
- Handmade Zeek Embroidery
- Machine Embroidered



Cap Fabrics

- Blazer
- Surge Wool
- Toptax (100% Polyester)
- Nechi (Polyester Cotton Mix)
- Zeen PC Fabric
- Rexine (Imitation Leather)
- Rib Rexine
- Barathea Fabric

Piping

- Available in All Colors & Materials
- Piping Between Crown & Bevel
- Piping Between Bevel & Band



MILITARY Peak Caps

FEATURES

To assist you when ordering

- A.** Crown
- B.** Piping Between Crown & Bevel
- C.** Bevel
- D.** Piping Between Bevel & Band
- E.** Band (Additional Braid Optional)
- F.** Welt (Optional)
- G.** Peak (Cloth, Leather or PVC)
- H.** Crown wire (Optional)
- I.** Front support (inside Cap)
- J.** Chin Strap
- K.** Buttons

When measuring, the tape should be over the middle of the forehead, then just above the ears to the back of the head to read the correct measurements, in inches or centimeter, then convert to cap size.

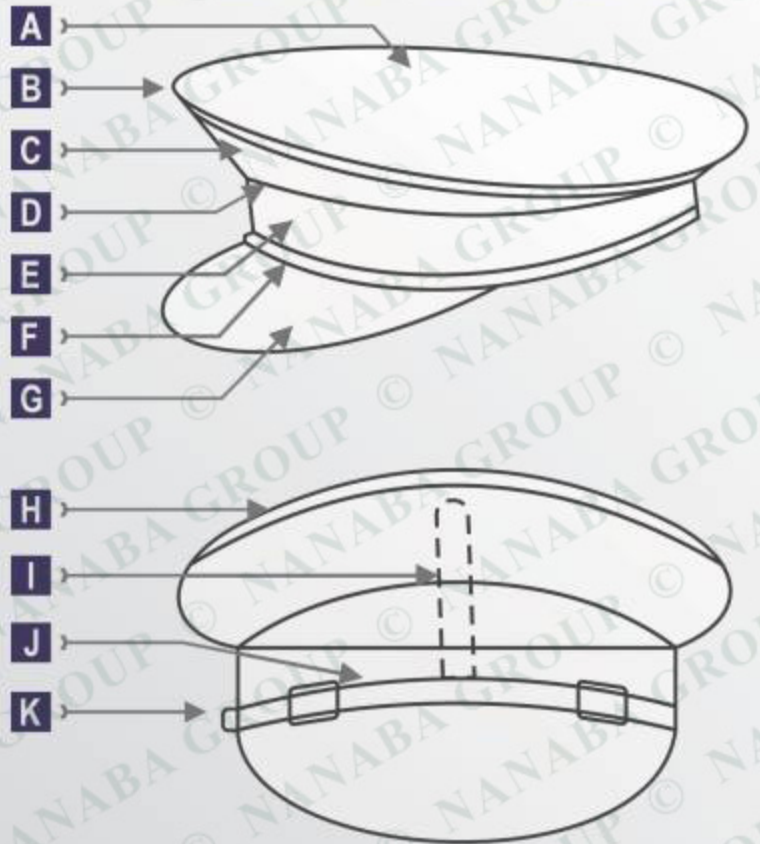

Standard Sizes of Uniform Caps

| CAP SIZE | 6 $\frac{1}{4}$ | 6 $\frac{3}{8}$ | 6 $\frac{1}{2}$ | 6 $\frac{5}{8}$ | 6 $\frac{3}{4}$ | 7 $\frac{1}{8}$ | 7 | 7 $\frac{1}{8}$ | 7 $\frac{1}{8}$ | 7 $\frac{3}{8}$ | 7 $\frac{1}{2}$ | 7 $\frac{5}{8}$ | 7 $\frac{3}{4}$ |
|----------|------------------|-----------------|------------------|------------------|------------------|------------------|----|------------------|------------------|------------------|------------------|-----------------|------------------|
| CMS | 50 | 51 | 52 | 53 | 54 | 55 | 56 | 57 | 58 | 59 | 60 | 61 | 62 |
| INCHES | 19 $\frac{5}{8}$ | 20 | 20 $\frac{1}{2}$ | 21 $\frac{7}{8}$ | 21 $\frac{1}{4}$ | 22 $\frac{5}{8}$ | 22 | 22 $\frac{3}{8}$ | 23 $\frac{3}{4}$ | 23 $\frac{1}{4}$ | 23 $\frac{5}{8}$ | 24 | 24 $\frac{3}{8}$ |

Peak Cap Packing Details

- One Box Contains: 16 PCs
- Box Dimension 23.0"/W, 22.0"/L, 14.0"/H
- Dimensional Weight: 25.0 KG
- Each Cap Dimensional Weight Approx: 1.56 KG
- 20 Feet Container Covers: 280 Box / 4480 PCs

> Global Box



Branding Packing Details

- Great Custom Branding Box: 01 Pc Packing
- Add Instruction Card With Your Company Logo
- Add SQU Coding With Your Company Logo
- Add Bar Code With Your Company Logo
- Add Tender Reference Code With Your Company Logo

> Individual Branding Box





NG - 3001

Fabrics: All fabrics are available for exterior & interior use
Accessories: All accessories parts are available
Embroidery: Handmade Bullion & Machine Embroidery



NG - 3002

Fabrics: All fabrics are available for exterior & interior use
Accessories: All accessories parts are available
Embroidery: Handmade Bullion & Machine Embroidery

107



NG - 3003

Fabrics: All fabrics are available for exterior & interior use
Accessories: All accessories parts are available
Embroidery: Handmade Bullion & Machine Embroidery



NG - 3004

Fabrics: All fabrics are available for exterior & interior use
Accessories: All accessories parts are available
Embroidery: Handmade Bullion & Machine Embroidery



NG - 3005

Fabrics: All fabrics are available for exterior & interior use
Accessories: All accessories parts are available
Embroidery: Handmade Bullion & Machine Embroidery



NG - 3006

Fabrics: All fabrics are available for exterior & interior use
Accessories: All accessories parts are available
Embroidery: Handmade Bullion & Machine Embroidery



NG - 3007

Fabrics: All fabrics are available for exterior & interior use
Accessories: All accessories parts are available
Embroidery: Handmade Bullion & Machine Embroidery



NG - 3008

Fabrics: All fabrics are available for exterior & interior use
Accessories: All accessories parts are available
Embroidery: Handmade Bullion & Machine Embroidery



NG - 3009

Fabrics: All fabrics are available for exterior & interior use
Accessories: All accessories parts are available
Embroidery: Handmade Bullion & Machine Embroidery



NG - 3010

Fabrics: All fabrics are available for exterior & interior use
Accessories: All accessories parts are available
Embroidery: Handmade Bullion & Machine Embroidery



NG - 3011

Fabrics: All fabrics are available for exterior & interior use
Accessories: All accessories parts are available
Embroidery: Handmade Bullion & Machine Embroidery



NG - 3012

Fabrics: All fabrics are available for exterior & interior use
Accessories: All accessories parts are available
Embroidery: Handmade Bullion & Machine Embroidery



NG - 3013

Fabrics: All fabrics are available for exterior & interior use
Accessories: All accessories parts are available
Embroidery: Handmade Bullion & Machine Embroidery



NG - 3014

Fabrics: All fabrics are available for exterior & interior use
Accessories: All accessories parts are available
Embroidery: Handmade Bullion & Machine Embroidery



NG - 3015

Fabrics: All fabrics are available for exterior & interior use
Accessories: All accessories parts are available
Embroidery: Handmade Bullion & Machine Embroidery



NG - 3016

Fabrics: All fabrics are available for exterior & interior use
Accessories: All accessories parts are available
Embroidery: Handmade Bullion & Machine Embroidery



NG - 3017

Fabrics: All fabrics are available for exterior & interior use
Accessories: All accessories parts are available
Embroidery: Handmade Bullion & Machine Embroidery



NG - 3018

Fabrics: All fabrics are available for exterior & interior use
Accessories: All accessories parts are available
Embroidery: Handmade Bullion & Machine Embroidery



NG - 3019

Fabrics: All fabrics are available for exterior & interior use
Accessories: All accessories parts are available
Embroidery: Handmade Bullion & Machine Embroidery



NG - 3020

Fabrics: All fabrics are available for exterior & interior use
Accessories: All accessories parts are available
Embroidery: Handmade Bullion & Machine Embroidery



NG - 3021

Fabrics: All fabrics are available for exterior & interior use
Accessories: All accessories parts are available
Embroidery: Handmade Bullion & Machine Embroidery



NG - 3022

Fabrics: All fabrics are available for exterior & interior use
Accessories: All accessories parts are available
Embroidery: Handmade Bullion & Machine Embroidery



NG - 3023

Fabrics: All fabrics are available for exterior & interior use
Accessories: All accessories parts are available
Embroidery: Handmade Bullion & Machine Embroidery



NG - 3024

Fabrics: All fabrics are available for exterior & interior use
Accessories: All accessories parts are available
Embroidery: Handmade Bullion & Machine Embroidery



NG - 3025

Fabrics: All fabrics are available for exterior & interior use
Accessories: All accessories parts are available
Embroidery: Handmade Bullion & Machine Embroidery



NG - 3026

Fabrics: All fabrics are available for exterior & interior use
Accessories: All accessories parts are available
Embroidery: Handmade Bullion & Machine Embroidery



NG - 3027

Fabrics: All fabrics are available for exterior & interior use
Accessories: All accessories parts are available
Embroidery: Handmade Bullion & Machine Embroidery



NG - 3028

Fabrics: All fabrics are available for exterior & interior use
Accessories: All accessories parts are available
Embroidery: Handmade Bullion & Machine Embroidery



NG - 3029

Fabrics: All fabrics are available for exterior & interior use
Accessories: All accessories parts are available
Embroidery: Handmade Bullion & Machine Embroidery



NG - 3030

Fabrics: All fabrics are available for exterior & interior use
Accessories: All accessories parts are available
Embroidery: Handmade Bullion & Machine Embroidery



NG - 3031

Fabrics: All fabrics are available for exterior & interior use
Accessories: All accessories parts are available
Embroidery: Handmade Bullion & Machine Embroidery



NG - 3032

Fabrics: All fabrics are available for exterior & interior use
Accessories: All accessories parts are available
Embroidery: Handmade Bullion & Machine Embroidery



NG - 3033

Fabrics: All fabrics are available for exterior & interior use
Accessories: All accessories parts are available
Embroidery: Handmade Bullion & Machine Embroidery



NG - 3034

Fabrics: All fabrics are available for exterior & interior use
Accessories: All accessories parts are available
Embroidery: Handmade Bullion & Machine Embroidery



NG - 3035

Fabrics: All fabrics are available for exterior & interior use
Accessories: All accessories parts are available
Embroidery: Handmade Bullion & Machine Embroidery



NG - 3036

Fabrics: All fabrics are available for exterior & interior use
Accessories: All accessories parts are available
Embroidery: Handmade Bullion & Machine Embroidery



NG - 3037



NG - 3042



NG - 3038



NG - 3043



NG - 3039



NG - 3044



NG - 3040



NG - 3045



NG - 3041



NG - 3046



NG - 3047



NG - 3052



NG - 3048



NG - 3053



NG - 3049



NG - 3054



NG - 3050



NG - 3055



NG - 3051



NG - 3056



NG - 3057



NG - 3062



NG - 3058



NG - 3063



NG - 3059



NG - 3064



NG - 3060



NG - 3065



NG - 3061



NG - 3066



NG - 3067



NG - 3072



NG - 3068



NG - 3073



NG - 3069



NG - 3074



NG - 3070

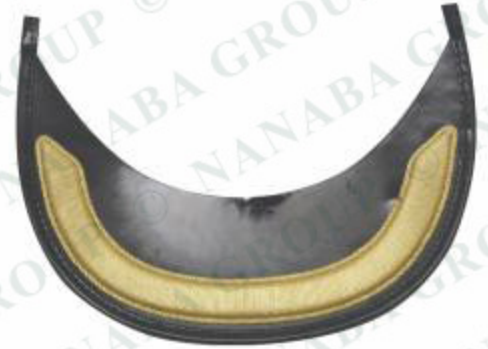

NG - 3075



NG - 3071



NG - 3076



NG - 3077



NG - 3082



NG - 3078



NG - 3083



NG - 3079



NG - 3084

117



NG - 3080



NG - 3085



NG - 3081



NG - 3086



NG - 3087



NG - 3092



NG - 3088



NG - 3093



NG - 3089



NG - 3094



NG - 3090



NG - 3095



NG - 3091



NG - 3096



NG - 3101



NG - 3111



NG - 3102



NG - 3112



NG - 3103



NG - 3113



NG - 3104



NG - 3114



NG - 3105



NG - 3115



NG - 3106



NG - 3116



NG - 3107



NG - 3117



NG - 3108



NG - 3118



NG - 3109



NG - 3119



NG - 3110



NG - 3120





NG - 3141



NG - 3151



NG - 3142



NG - 3152



NG - 3143



NG - 3153



NG - 3144



NG - 3154



NG - 3145



NG - 3155



NG - 3146



NG - 3156



NG - 3147



NG - 3157



NG - 3148



NG - 3158



NG - 3149



NG - 3159



NG - 3150



NG - 3160





NG - 3201

Fabrics: All fabrics are available for exterior & interior use
Accessories: All accessories parts are available
Embroidery: Handmade Bullion & Machine Embroidery



NG - 3202

Fabrics: All fabrics are available for exterior & interior use
Accessories: All accessories parts are available
Embroidery: Handmade Bullion & Machine Embroidery



NG - 3203

Fabrics: All fabrics are available for exterior & interior use
Accessories: All accessories parts are available
Embroidery: Handmade Bullion & Machine Embroidery



NG - 3204

Fabrics: All fabrics are available for exterior & interior use
Accessories: All accessories parts are available
Embroidery: Handmade Bullion & Machine Embroidery



NG - 3205

Fabrics: All fabrics are available for exterior & interior use
Accessories: All accessories parts are available
Embroidery: Handmade Bullion & Machine Embroidery



NG - 3206

Fabrics: All fabrics are available for exterior & interior use
Accessories: All accessories parts are available
Embroidery: Handmade Bullion & Machine Embroidery



NG - 3207

Fabrics: All fabrics are available for exterior & interior use
Accessories: All accessories parts are available
Embroidery: Handmade Bullion & Machine Embroidery



NG - 3208

Fabrics: All fabrics are available for exterior & interior use
Accessories: All accessories parts are available
Embroidery: Handmade Bullion & Machine Embroidery



NG - 3209

Fabrics: All fabrics are available for exterior & interior use
Accessories: All accessories parts are available
Embroidery: Handmade Bullion & Machine Embroidery



NG - 3210

Fabrics: All fabrics are available for exterior & interior use
Accessories: All accessories parts are available
Embroidery: Handmade Bullion & Machine Embroidery



NG - 3211

Fabrics: All fabrics are available for exterior & interior use
Accessories: All accessories parts are available
Embroidery: Handmade Bullion & Machine Embroidery



NG - 3212

Fabrics: All fabrics are available for exterior & interior use
Accessories: All accessories parts are available
Embroidery: Handmade Bullion & Machine Embroidery



NG - 3213

Fabrics: All fabrics are available for exterior & interior use
Accessories: All accessories parts are available
Embroidery: Handmade Bullion & Machine Embroidery



NG - 3214

Fabrics: All fabrics are available for exterior & interior use
Accessories: All accessories parts are available
Embroidery: Handmade Bullion & Machine Embroidery

125



NG - 3215

Fabrics: All fabrics are available for exterior & interior use
Accessories: All accessories parts are available
Embroidery: Handmade Bullion & Machine Embroidery



NG - 3216

Fabrics: All fabrics are available for exterior & interior use
Accessories: All accessories parts are available
Embroidery: Handmade Bullion & Machine Embroidery



NG - 3217

Fabrics: All fabrics are available for exterior & interior use
Accessories: All accessories parts are available
Embroidery: Handmade Bullion & Machine Embroidery



NG - 3218

Types: All Type Of Plumes & Hackles are available
Colors & Sizes: All Colors & Sizes are available
Feathers: Different Feather Options are available



NG - 3219

Fabrics: All fabrics are available for exterior & interior use
 Accessories: All accessories parts are available
 Embroidery: Handmade Bullion & Machine Embroidery



NG - 3220

Fabrics: All fabrics are available for exterior & interior use
 Accessories: All accessories parts are available
 Embroidery: Handmade Bullion & Machine Embroidery



NG - 3221

Fabrics: All fabrics are available for exterior & interior use
 Accessories: All accessories parts are available
 Embroidery: Handmade Bullion & Machine Embroidery



NG - 3222

Fabrics: All fabrics are available for exterior & interior use
 Accessories: All accessories parts are available
 Embroidery: Handmade Bullion & Machine Embroidery



NG - 3223

Badges: All kinds of badges are available
 Sizes: All sizes are available
 Rare Side: All backing options are available



NG - 3224

Colors & Sizes: All colors & sizes are available
 Materials: All materials are available
 Plaiting: All gold & silver plaiting is available



Uniform berets

NANBA

GROUP

www.nanbagroup.com

The Way We Work



We Do Branding...

1. We buy the wool yarn
2. Make the beret bloom from the machine
3. Sew up the beret bloom from another machine & man made
4. We check every beret
5. Washing the beret by machine
6. Shrink the beret
7. Take the beret to color factory make color
8. Burn the beret
9. Barbering the beret
10. Clean the beret by machine
11. Sewing the lining and edge
12. Clean the stitching, make the Eyelets
13. Check the beret
14. Package





NG - 3301

Colors & Sizes: All Colors & Sizes are Available
Lining: All Lining Fabrics are Available
Branding: All Branding Options are Available



NG - 3302

Colors & Sizes: All Colors & Sizes are Available
Lining: All Lining Fabrics are Available
Branding: All Branding Options are Available



NG - 3303

Colors & Sizes: All Colors & Sizes are Available
Lining: All Lining Fabrics are Available
Branding: All Branding Options are Available



NG - 3304

Colors & Sizes: All Colors & Sizes are Available
Lining: All Lining Fabrics are Available
Branding: All Branding Options are Available



NG - 3305

Colors & Sizes: All Colors & Sizes are Available
Lining: All Lining Fabrics are Available
Branding: All Branding Options are Available



NG - 3306

Colors & Sizes: All Colors & Sizes are Available
Lining: All Lining Fabrics are Available
Branding: All Branding Options are Available



NG - 3307

Colors & Sizes: All Colors & Sizes are Available
Lining: All Lining Fabrics are Available
Branding: All Branding Options are Available



NG - 3308

Colors & Sizes: All Colors & Sizes are Available
Lining: All Lining Fabrics are Available
Branding: All Branding Options are Available



NG - 3309

Colors & Sizes: All Colors & Sizes are Available
Lining: All Lining Fabrics are Available
Branding: All Branding Options are Available



NG - 3310

Colors & Sizes: All Colors & Sizes are Available
Lining: All Lining Fabrics are Available
Branding: All Branding Options are Available



NG - 3311

Colors & Sizes: All Colors & Sizes are Available
Lining: All Lining Fabrics are Available
Branding: All Branding Options are Available



NG - 3312

Colors & Sizes: All Colors & Sizes are Available
Lining: All Lining Fabrics are Available
Branding: All Branding Options are Available



NG - 3313

Colors & Sizes: All Colors & Sizes are Available
Lining: All Lining Fabrics are Available
Branding: All Branding Options are Available



NG - 3314

Colors & Sizes: All Colors & Sizes are Available
Lining: All Lining Fabrics are Available
Branding: All Branding Options are Available



NG - 3315

Colors & Sizes: All Colors & Sizes are Available
Lining: All Lining Fabrics are Available
Branding: All Branding Options are Available



NG - 3316

Colors & Sizes: All Colors & Sizes are Available
Lining: All Lining Fabrics are Available
Branding: All Branding Options are Available



NG - 3317

Colors & Sizes: All Colors & Sizes are Available
Lining: All Lining Fabrics are Available
Branding: All Branding Options are Available



NG - 3318

Colors & Sizes: All Colors & Sizes are Available
Lining: All Lining Fabrics are Available
Branding: All Branding Options are Available



NG - 3319

Colors & Sizes: All Colors & Sizes are Available
Lining: All Lining Fabrics are Available
Branding: All Branding Options are Available



NG - 3320

Colors & Sizes: All Colors & Sizes are Available
Lining: All Lining Fabrics are Available
Branding: All Branding Options are Available



NG - 3321

Colors & Sizes: All Colors & Sizes are Available
Lining: All Lining Fabrics are Available
Branding: All Branding Options are Available



NG - 3322

Colors & Sizes: All Colors & Sizes are Available
Lining: All Lining Fabrics are Available
Branding: All Branding Options are Available



NG - 3323

Colors & Sizes: All Colors & Sizes are Available
Lining: All Lining Fabrics are Available
Branding: All Branding Options are Available



NG - 3324

Colors & Sizes: All Colors & Sizes are Available
Lining: All Lining Fabrics are Available
Branding: All Branding Options are Available

Berets

Berets Features Offers

Strengthening Ties

- Cotton OR Silk
- Polyester
- Polyester / Cotton Mix



Eyelets

Available In All Diamete Sizes & Quality



Wool Quality

- 100% Merino Wool
- 98% Wool 2% Other Yarn
- 95% Wool 5% Other Yarn
- 92% Wool 8% Other Yarn



Headband

- Leather Superior Quality (Matt or Shine)
- Imitation Leather (Standard Headband)
- Ribbon Headband



Inner Lining

- 100% Cotton
- Satin Silk
- Polyester
- Polyester / Cotton Mix



Size in Centimeters

- X-Small 50cm, 53cm
- Small 54cm, 55cm
- Medium 56cm, 57cm
- Large 58cm, 59cm
- X-Large 60cm, 61cm
- XX-Large 62, 63, 64cm



Branding Options

- Screen Printing On Inner Lining
- Branding Packaging
- Branding Instruction Cards
- Branding Size & Care Labeling

Hood Quality Before Dying:

Front View



Premium Quality

Standard Quality

Back View

Front View



Headband Options:



Ribbon

Immitation Leather

Real Leather



Branding Instruction Card & Labeling



Colors Available:

Black, Navy Blue, Royal Blue, Lt Blue, Green, Red, Burgundy, Dark Hunter Green, Ivory, Mauve, Orange, Purple, Yellow etc



Printing Option On Inner Lining



EPAULETTES

SHOULDERS SLIDERS



Epaulettes | Synopsis

Epaulettes are a type of ornamental shoulder piece or decoration used as insignia of rank by armed forces and other organizations. Colloquially, the word has also come to refer to some types of shoulder strap.

Epaulettes are fastened to the shoulder by a shoulder strap, a small strap parallel to the shoulder seam and the button near the collar, or by laces on the underside of the epaulette passing through holes in the shoulder of the coat.

The placement of the epaulette, its color and the length and diameter of its bullion fringe are used to signify the wearer's rank. At the join of the fringe and the shoulderpiece is often a metal piece in the form of a crescent. Although originally worn in the field, epaulettes are more common today on dress or ceremonial uniforms. Shoulder straps are also found on civilian clothing that derives from military uniforms.

We had received abundant testimonials by our various clients saying that our manufactured epaulettes are best both in material and craftsmanship. Simply a fantastic quality, please place an order and see the difference.





NG - 3401



NG - 3402



NG - 3403



NG - 3404



NG - 3405



NG - 3406



NG - 3407



NG - 3408



NG - 3409



NG - 3410



NG - 3411



NG - 3412



NG - 3413



NG - 3414



NG - 3415



NG - 3416



NG - 3417



NG - 3418



NG - 3419



NG - 3420



NG - 3421



NG - 3422



NG - 3423



NG - 3424



NG - 3425

136



NG - 3426



NG - 3427



NG - 3428



NG - 3429



NG - 3430



NG - 3431



NG - 3432



NG - 3433



NG - 3434



NG - 3435



137

NG - 3436



NG - 3437



NG - 3438



NG - 3439



NG - 3440



NG - 3441



NG - 3442



NG - 3443



NG - 3444



NG - 3445



NG - 3446



NG - 3447



NG - 3448



NG - 3449



NG - 3450



NG - 3451



NG - 3452



NG - 3453



NG - 3454



NG - 3455

138



NG - 3456



NG - 3457



NG - 3458



NG - 3459



NG - 3460



NG - 3461



NG - 3462



NG - 3463



NG - 3464



NG - 3465



NG - 3466



NG - 3467



NG - 3468



NG - 3469



NG - 3470



NG - 3471



NG - 3472



NG - 3473



NG - 3474



NG - 3475

141



NG - 3476



NG - 3477



NG - 3478



NG - 3479



NG - 3480



NG - 3481



NG - 3482



NG - 3483



NG - 3484



NG - 3485



NG - 3486



NG - 3487



NG - 3488



NG - 3489



NG - 3490



NG - 3491



NG - 3492



NG - 3493



NG - 3494



NG - 3495

142



NG - 3496



NG - 3497



NG - 3498



NG - 3499



NG - 3500



NG - 3501



NG - 3502



NG - 3503



NG - 3504



NG - 3505

143



NG - 3506



NG - 3507



NG - 3508



NG - 3509



NG - 3510



NG - 3511



NG - 3512



NG - 3513



NG - 3514



NG - 3515



NG - 3516



NG - 3517



NG - 3518



NG - 3519



NG - 3520



NG - 3521



NG - 3522



NG - 3523



NG - 3524



NG - 3525

144



NG - 3526



NG - 3527



NG - 3528



NG - 3529



NG - 3530



NG - 3531



NG - 3532



NG - 3533



NG - 3534



NG - 3535



NG - 3536



NG - 3537



NG - 3538

145



NG - 3539



NG - 3540



NG - 3541



NG - 3542



NG - 3543

Cord Shoulder



NG - 3544



NG - 3545



NG - 3546



NG - 3547



NG - 3548



NG - 3549



NG - 3550



NG - 3551



NG - 3552



NG - 3553



NG - 3554



NG - 3555



NG - 3556



NG - 3557



NG - 3558



NG - 3559



NG - 3560



NG - 3561



NG - 3562



NG - 3563



NG - 3564



NG - 3565



NG - 3566



NG - 3567



NG - 3568



NG - 3569



NG - 3570



NG - 3571



NG - 3572



NG - 3573

148



NG - 3574



NG - 3575



NG - 3576



NG - 3577



NG - 3578



NG - 3579



NG - 3580



NG - 3581



NG - 3582



NG - 3583



NG - 3584



NG - 3585



NG - 3586



NG - 3587



NG - 3588



NG - 3589



NG - 3590



NG - 3591



NG - 3592



NG - 3593



NG - 3594



NG - 3595



NG - 3596



NG - 3597



NG - 3598



NG - 3599



NG - 3600



NG - 3601



NG - 3602



NG - 3603

150



NG - 3604



NG - 3605



NG - 3606



NG - 3607



NG - 3608

Cord Shoulder

The image features a dark blue background with a prominent diagonal stripe in a lighter shade of blue. The stripe is bordered by thin black lines. In the upper right corner, the company name 'NANBA' is written in a large, white, sans-serif font, with 'GROUP' in a smaller font size directly below it. A horizontal line is positioned between 'NANBA' and 'GROUP'. Below this line, the website address 'www.nanbagroup.com' is displayed in a small, white, sans-serif font. The background is covered with a repeating watermark of '© NANABA GROUP' in a light grey color, oriented diagonally to match the stripe.

NANBA

GROUP

www.nanbagroup.com

**GIVING UNIQUE
TOUCH & PRIDE TO
UNIFORM**



MILITARY Chevrons



Size as per originally made



Chevrons



Size as per originally made

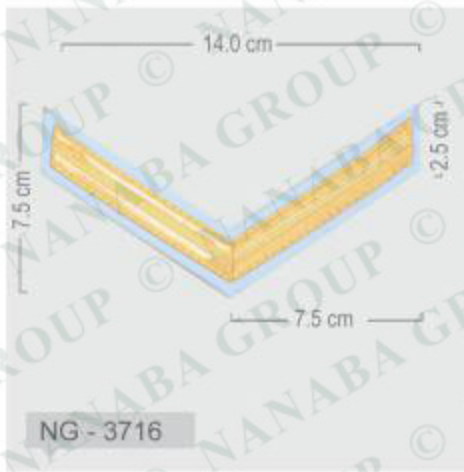

154



Chevrons



MILITARY GORGETS

- Our Commitment is always Focused to Develop Quality Product Using best Available Materials.
- Our Made Gorgets is a Perfect Companion to your Uniform, Winning the Elegance.
- Our Skilled Workmen are at their best when making Gorgets Simply Enrapturing.



Feel Elite...

Uniform Really Matters



NANABA

GROUP

www.nanbagroup.com

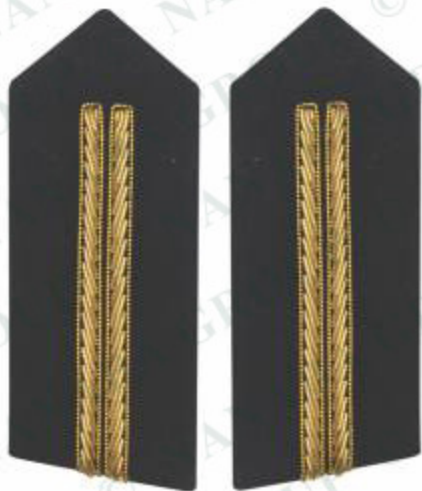

NG - 3801

Embroidery: All embroidery options are available
Backing: Metal Clips, Velcro, Fabric etc.



NG - 3802

Embroidery: All embroidery options are available
Backing: Metal Clips, Velcro, Fabric etc.



NG - 3803

Embroidery: All embroidery options are available
Backing: Metal Clips, Velcro, Fabric etc.

157



NG - 3804

Embroidery: All embroidery options are available
Backing: Metal Clips, Velcro, Fabric etc.



NG - 3805

Embroidery: All embroidery options are available
Backing: Metal Clips, Velcro, Fabric etc.



NG - 3806

Embroidery: All embroidery options are available
Backing: Metal Clips, Velcro, Fabric etc.



NG - 3807

Embroidery: All embroidery options are available
Backing: Metal Clips, Velcro, Fabric etc.



NG - 3808

Embroidery: All embroidery options are available
Backing: Metal Clips, Velcro, Fabric etc.



NG - 3809

Embroidery: All embroidery options are available
Backing: Metal Clips, Velcro, Fabric etc.

Gorgets



NG - 3810

Embroidery: All embroidery options are available
Backing: Metal Clips, Velcro, Fabric etc.



NG - 3811

Embroidery: All embroidery options are available
Backing: Metal Clips, Velcro, Fabric etc.



NG - 3812

Embroidery: All embroidery options are available
Backing: Metal Clips, Velcro, Fabric etc.



NG - 3813

Embroidery: All embroidery options are available
Backing: Metal Clips, Velcro, Fabric etc.



NG - 3814

Embroidery: All embroidery options are available
Backing: Metal Clips, Velcro, Fabric etc.



NG - 3815

Embroidery: All embroidery options are available
Backing: Metal Clips, Velcro, Fabric etc.



NG - 3816

Embroidery: All embroidery options are available
Backing: Metal Clips, Velcro, Fabric etc.



NG - 3817

Embroidery: All embroidery options are available
Backing: Metal Clips, Velcro, Fabric etc.



NG - 3818

Embroidery: All embroidery options are available
Backing: Metal Clips, Velcro, Fabric etc.

Gorgetts

Ceremonial Sashes

NANBA
GROUP

www.nanbagroup.com



NG - 3911

Belly Sash



NG - 3901



NG - 3902



NG - 3903



NG - 3904

NG - 3905



NG - 3906



NG - 3907



NG - 3908



NG - 3909



NG - 3910

NANABA

GROUP

www.nanbagroup.com

... NANABA Listens more than you Speak ...

BELTS

- ◆ Tassel Waist Belts
- ◆ Stable Webbing Belts
- ◆ Ceremonial Braided Belts
- ◆ Army, Police, Air-Force Belts
- ◆ Shoulders Holsters Rigs
- ◆ Flag Carrying Belts
- ◆ Sam Browne Belts With Frog
- ◆ Sword Belts With 2 Slings
- ◆ Formal & Duty Belts
- ◆ Dressing & Fashion Belts





— Class —

The Best Quality ever Wished, Crafted By Desired Hands at NANBA premises

Think Quality, Think NANBA

STABLE
BELTS

WE PROVIDE
BEST
SERVICE



NG - 4001



NG - 4002



NG - 4003

NG - 4004

NANBA
GROUP

www.nanbagroup.com



NG - 4005



NG - 4006



NG - 4007



NG - 4008



NG - 4009

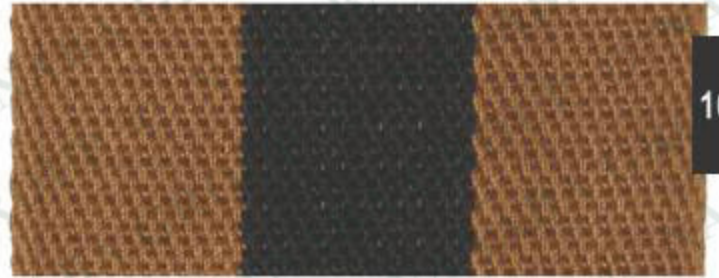

NG - 4010

164



NG - 4011



NG - 4012



NG - 4013



NG - 4014

Stable Belts Range



NG - 4015



NG - 4016



NG - 4017



NG - 4018

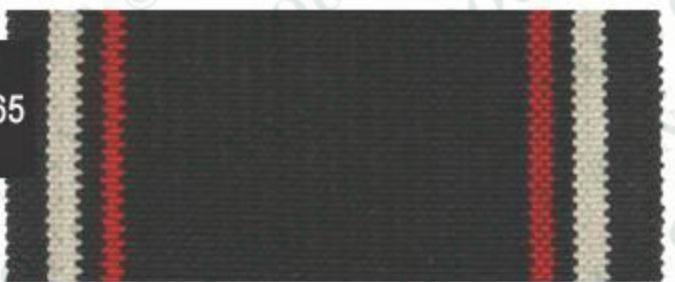

165

NG - 4019



NG - 4020



NG - 4021



NG - 4022



NG - 4023



NG - 4024

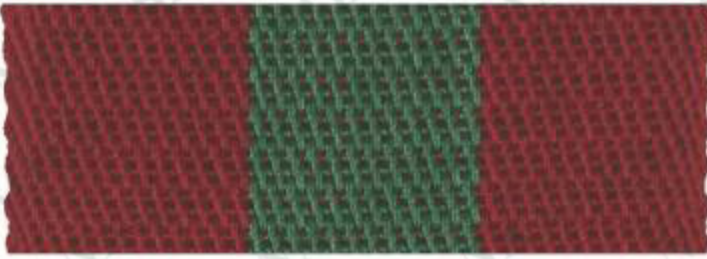

NG - 4025



NG - 4026



NG - 4027



NG - 4028



NG - 4029



NG - 4030



NG - 4031

166



NG - 4032



NG - 4033



NG - 4034

Stable Belts Range

WAIST
SASH TASSEL

BELTS

NANABA

GROUP

www.nanbagroup.com



NG - 4101 Viscose Ribbons



NG - 4102 Viscose Ribbons & Mylar Lines



NG - 4104 Gold & Silver Mylar



NG - 4105 Mylar & Viscose Ribbons

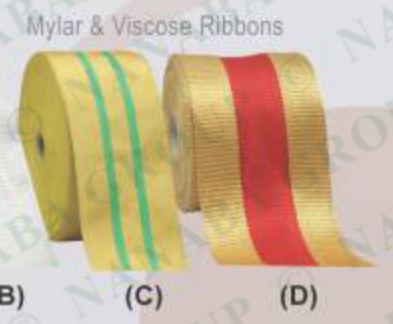

NG - 4103

Viscose Ribbons & Mylar Pattern

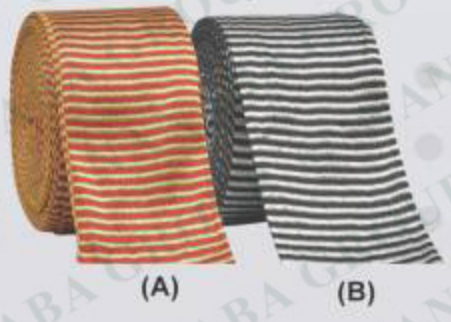



NG - 4106



NG - 4108



NG - 4107



NG - 4109



NG - 4110



NG - 4112



NG - 4111



NG - 4113

NG - 4114



NG - 4115



NG - 4116



NG - 4117



NG - 4118



NG - 4119



NG - 4120



NG - 4121



LEATHER BELTS



NG - 4201



NG - 4203



NG - 4202



NG - 4204

NG - 4205

NANBA
GROUP

www.nanbagroup.com



NG - 4206



NG - 4207



NG - 4208



NG - 4209



NG - 4210



NG - 4211



NG - 4212



NG - 4213



NG - 4214



NG - 4215



NG - 4216



NG - 4217



NG - 4218



NG - 4219



NG - 4220



NG - 4221

NANABA

GROUP

www.nanbagroup.com

Military Wallet

We emboss all our Products "Full Grain Leather - Made by NANABA

- As a thin wallet for men.
- It features a construction that eliminates bulge by folding flat
- Personalize your new full grain leather wallet with custom laser engraving



LIVE A LUXURIOUS LIFE

Think Quality
Think NANBA...



“Our Dedicated Team Has Great Experience In Strategy, Innovation, Foresight and Products Development”



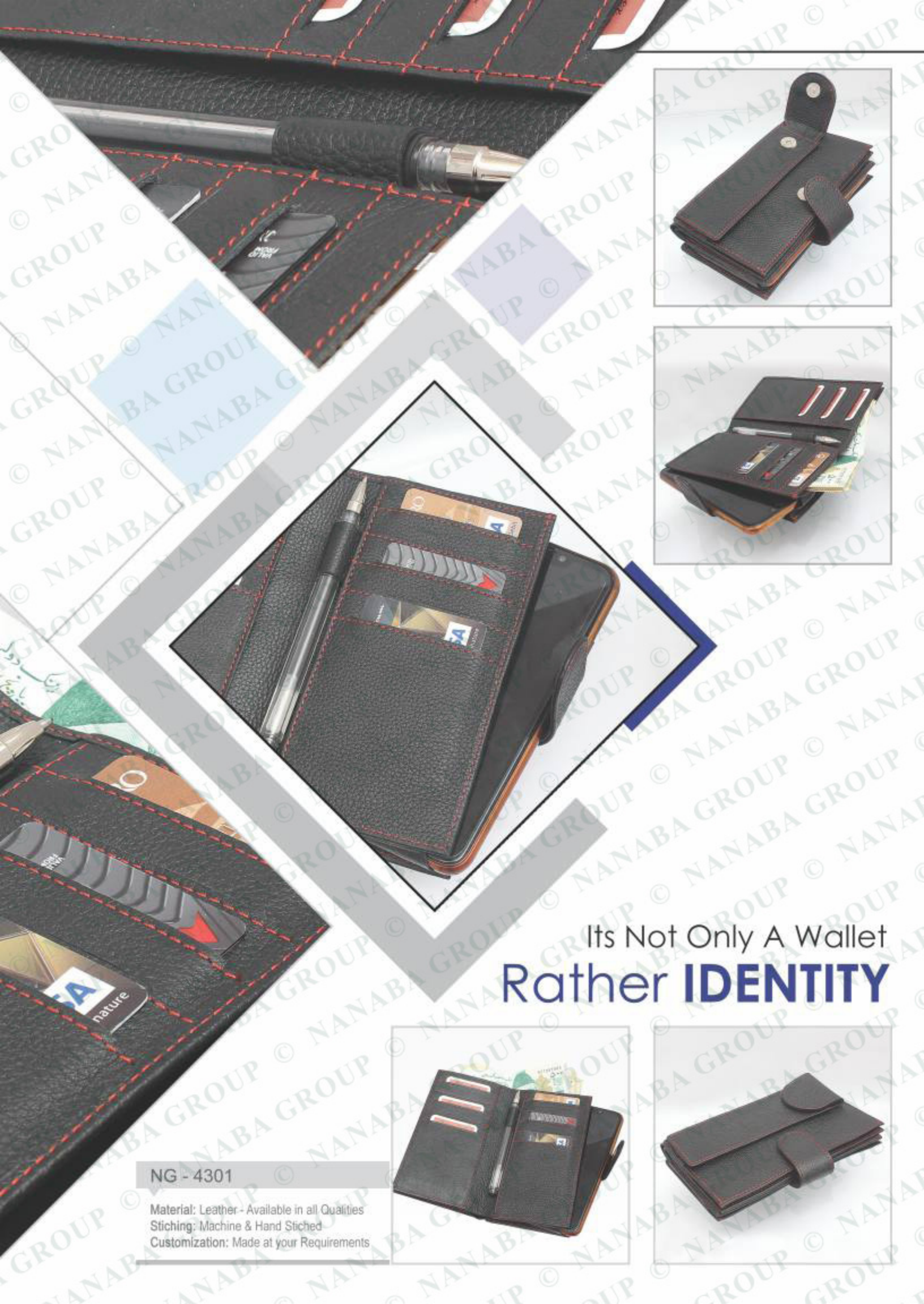

Its Not Only A Wallet
Rather **IDENTITY**

NG - 4301

Material: Leather - Available in all Qualities
Stitching: Machine & Hand Stitched
Customization: Made at your Requirements

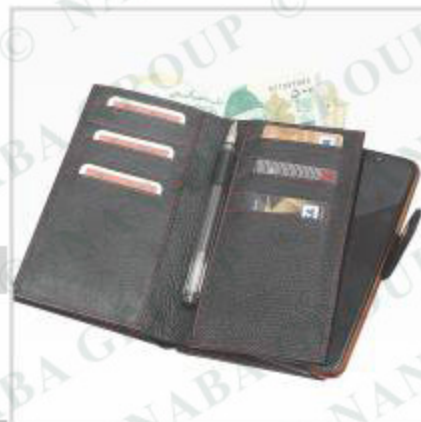



NG - 4302

Material: Leather - Available in all Qualities
Stitching: Machine & Hand Stitched
Customization: Made at your Requirements



NG - 4303

Material: Leather - Available in all Qualities
Stitching: Machine & Hand Stitched
Customization: Made at your Requirements



NG - 4304

Material: Leather - Available in all Qualities
Stitching: Machine & Hand Stitched
Customization: Made at your Requirements



NG - 4305

Material: Leather - Available in all Qualities
Stitching: Machine & Hand Stitched
Customization: Made at your Requirements



NG - 4306

Material: Leather - Available in all Qualities
Stitching: Machine & Hand Stitched
Customization: Made at your Requirements



NG - 4307

Material: Leather - Available in all Qualities
Stitching: Machine & Hand Stitched
Customization: Made at your Requirements



NG - 4308

Material: Leather - Available in all Qualities
Stitching: Machine & Hand Stitched
Customization: Made at your Requirements



NG - 4309

Material: Leather - Available in all Qualities
Stitching: Machine & Hand Stitched
Customization: Made at your Requirements



NG - 4310

Material: Leather - Available in all Qualities
Stitching: Machine & Hand Stitched
Customization: Made at your Requirements



NG - 4311

Material: Leather - Available in all Qualities
Stitching: Machine & Hand Stitched
Customization: Made at your Requirements



NG - 4312

Material: Leather - Available in all Qualities
Stitching: Machine & Hand Stitched
Customization: Made at your Requirements



NG - 4313

Material: Leather - Available in all Qualities
Stitching: Machine & Hand Stitched
Customization: Made at your Requirements



NG - 4314

Material: Leather - Available in all Qualities
Stitching: Machine & Hand Stitched
Customization: Made at your Requirements



NG - 4315

Material: Leather - Available in all Qualities
Stitching: Machine & Hand Stitched
Customization: Made at your Requirements



NG - 4316

Material: Leather - Available in all Qualities
Stitching: Machine & Hand Stitched
Customization: Made at your Requirements



NG - 4317

Material: Leather - Available in all Qualities
Stitching: Machine & Hand Stitched
Customization: Made at your Requirements

ARM BRASSARDS

ARM
BANDS
& GAITERS

WE HAVE DIFFERENT
AND CREATIVE
SOLUTIONS



NANBA
GROUP

www.nanbagroup.com



NG - 4401

Material: 100% Cotton Fabric
Printing: Screen Printing
Sizes: Fit to Custom Size



NG - 4402

Material: 100% Cotton Fabric
Printing: Screen Printing
Sizes: Fit to Custom Size



NG - 4403

Material: 100% Cotton Fabric
Printing: Screen Printing
Sizes: Fit to Custom Size



NG - 4404

Material: 100% Cotton Fabric
Printing: Screen Printing
Sizes: Fit to Custom Size



NG - 4405

Material: 100% Cotton Fabric
Printing: Screen Printing
Sizes: Fit to Custom Size



NG - 4406

Material: 100% Cotton Fabric
Printing: Screen Printing
Sizes: Fit to Custom Size

178



NG - 4407

Material: Blazer
Letters: MP in Blazer
Sizes: Fit to Custom Size



NG - 4408

Material: Elasticized Cotton, Latex Tread
Hooks: Hook-On Style
Sizes: One Size Fits All



NG - 4409

Material: Cotton/Polyester
Closure: Full Length Velcro & Zip
Sizes: Fit to Custom Size

Brassards, Arm Bands, Gaiters

MAKING YOU TO FEEL
Awesome

**NECK TIE
BOW TIE
POCKET SQUARE
CUMMERBUND**



NG - 4501



NG - 4502



NG - 4503



NG - 4504

NANBA

GROUP

www.nanbagroup.com

**MAKES
THE
DIFFERENCE**



NG - 4602

NG - 4603

NG - 4601

**OFFICER CANES
BATON
PACE STICKS**



NANABA

GROUP

www.nanbagroup.com



TACTICAL GLOVES

- * We use the best raw material and workmanship in making vast range of our gloves products.
- * Our range covers Police, Military, Pilot, Aviation industry, Security, Tactical, Protection, Ceremonial Scouts, Universities, Fire Fighters, Shooting, Etc Design and development at its best. Simple Unique in term of wearing, desing and performance
- * Our gloves are our identity.

info

"Think out of the box" that is what we have always applied in our product line. As a matter of fact, our team spends as much time as required on "Research & Development" since we understand a good product is always a strong base of relationship between business partners.

We don't seek to do business for one time, we wish for years to years business that is why our main focus is best services, good quality product and in time delivery time. Our clients are our long run business partners whom we have long association to win market place together.

Think Quality, Think NANBA



NG - 4701 Tactical Gloves

Palm: Amara , Digital Leather (Silicone Amara Also used for Grip)
Backside: Forway, Neoprene, Amara, Safety Nickel Protection
Wrist: Nylon, Amara, Velcro Closures



NG - 4702 Tactical Gloves

Material: Amara, Silicone Grip Printing
Backside: Forway, Amara, Safety Nickel Protection
Wrist: Nylon, Amara, Velcro Closures



NG - 4703 Tactical Half Finger

Palm: Amara, Forway Silicon Grip Printing on Amara
Backside: Forway, Amara, Safety Nickel Protection
Wrist: Nylon, Smara, Velcro Closures



NG - 4704 Tactical Half Finger

Palm: Amara, Silicon Grip Printing
Backside: Forway, Amara, Safety Nickel Protection
Wrist: Nylon, Amara, Velcro Closures



NG - 4705 Tactical

Palm: Amara, Silicon Printing For Grip
Backside: Forway, Amara, Safety Material
Wrist: Neoprene, Rubber Logo Branding, Velcro Closures



NG - 4706 Shooting

Palm: Amara, Touch Leather
Backside: Forway, Amara, Safety Material, Machine Embroidery
Wrist: Neoprene, Rubber Logo Branding, Velcro Closures



NG - 4707 Tactical

Palm: Goat Leather, Palm Rubber For Safety
Backside: Nomex Fabric, Leather & Nickel Protection
Wrist: Rubber Logo and Velcro Closures



NG - 4708 Tactical

Palm: Amara, Neoprene
Backside: Forway, Amara, Safety Material
Wrist: Amara Strape, Velcro Closures



NG - 4709 Pilot Gloves

Palm: Goat Leather, Nomex Fabric, Silicon Grip
Backside: Nomex, Elastic Stitch
Wrist: Nomex & Goat Leather



NG - 4710 Tactical

Palm: Amara, Touch Function
Backside: Direct Inject For Safety, Forway, Amara
Wrist: Neoprene, Velcro Closures



NG - 4711 Police

Palm: Amara, Digital Printing, Touch
BackSide: Nomex, Leather, Rubber For Safety
Wrist: Leather Strap, Velcro Closures



NG - 4712 Police

Palm: Amara, Silicon Printing For Grip & Safety Touch
BackSide: Forwary, Embossing,
Wrist: Neoprene, Embossing and Velcro Closures



NG - 4713 Tactical

Palm: Amara, Digital Printing on Amara, Touch
BackSide: Amara, Forwary, Safety Rubber
Wrist: Neoprene, PU Magzi, Velcro Closures



NG - 4714 Tactical

Palm: Amara, Silicon Printing For Grip & Safety Material
BackSide: Polyester, Direct Inject
Wrist: Nylon Elastic, Rubber Logo Strap, Velcro Closures



NG - 4715 Tactical & Safety

Palm: Amara, Digital Printing on Amara, Forwary
BackSide: Amara, Forwary, Direct Inject Rubber
Wrist: Amara, Velcro Closures



NG - 4716 Tactical & Safety

Palm: Amara, Carbide Fabric For Better Grip
BackSide: Forwary Direct Inject, Nylon Piping
Wrist: Neoprene, Rubber logo Strap, PU Velcro Closures



NG - 4717 Pilot

Palm: Goat Leather
BackSide: Nomex & Goat Leather
Wrist: Elastic Closures



NG - 4718 Security

Palm: Goat Leather
BackSide: Nomex & Goat Leather
Wrist: Velcro Closures



NG - 4719 Pilot

Palm: Digital Amara
BackSide: Nomex
Wrist: Elastic Closures



NG - 4720 Pilot

Palm: Goat Leather (Aniline)
BackSide: Nomex & Goat Leather (Aniline)
Wrist: Elastic Closures



NG - 4721 Pilot

Palm: Goat Leather
BackSide: Nomex & Goat Leather
Wrist: Elastic Closures



NG - 4722 Pilot

Palm: Goat Leather
BackSide: Nomex & Goat Leather
Wrist: Elastic Closures



NG - 4723 Tactical

Palm: Amara, Touch Function
BackSide: Forway, Centre Neoprene,
Wrist: Neoprene & Rubber Logo



NG - 4724 Police, Safety Half Finger

Palm: Amara, Touch Function
BackSide: Polyester Fabric, Nylon Protection for safety
Wrist: Elastic & Velcro Closures



NG - 4725

Palm: 100% Cotton Gloves
Stitch: Good Stitching Quality
Wash: Washable Fabric



NG - 4726 Police

Palm: Leather Front with Touch
BackSide: Neoprene, Leather, Safety Material
Wrist: Leather & Velcro Closures



NG - 4727 Police/Military

Palm: Leather
BackSide: Leather Nickel Protection, Forway
Wrist: Nylon Piping, Velcro Closures



NG - 4728 Tactical Police/Military

Palm: Amara, Silicon
BackSide: Forway, Amara, Nickel Protection
Wrist: Velcro Closures



NG - 4729 Hunting Gloves

Palm: Digital Soft Shell, Silicon Grippy for Fashion
 BackSide: Digital Soft Shell Printing
 Wrist: Elastic Closures



NG - 4730 Military Winter

Palm: Printing Amara, Nomex , Elastic Band, Front Zip, Velcro
 BackSide: Nomex, Neoprene, Amara Safety Rubber
 Wrist: PU Piping Closures



NG - 4731

Palm: Amara for Air Venting, Digital Soft Shell
 BackSide: Digital Soft Shell Printing
 Wrist: Digital Soft Shell Closures



NG - 4732

Palm: Digital Soft Shell, Reinforced Palm with Grip
 BackSide: Digital Soft Shell Printing and Elastic Closures
 Wrist: Velcro Closures, Soft Shell PU Pipping



NG - 4733

Palm: Digital Soft Shell, Amara, Elastic
 BackSide: Digital Soft Shell Printing
 Wrist: Elastic Closures



NG - 4734

Palm: Digital Soft Shell, Silicon Grip
 BackSide: Digital Soft Shell Printing
 Wrist: Amara/Neoprene with Velcro Closures



NG - 4735 Tactical

Palm: Leather & Digital Leather Printing
Backside: Leather, Forway, Nickel Protection, Nylon Venting
Wrist: Velcro Closures with Leather



NG - 4736 Tactical

Palm: Amara, Touch on Thumb and Finger
Backside: Forway Printing
Wrist: Neoprene & Velcro Closures



NG - 4737 Tactical

Palm: Amara, Touch Leather Function, Rubber injected
Backside: Forway Printing, Direct Inject,
Wrist: Elastic Rubber Logo & Velcro Closures



NG - 4738 Tactical

Palm: Goat Leather, Palm Rubber For Safety
Backside: Nomex Fabric, Leather & Nickel Protection
Wrist: Rubber Logo and Velcro Closures



NG - 4739 Police

Palm: Goat Leather (Aniline)
Backside: Nomax, Safety Function, Leather
Wrist: Neoprene, Rubber logo, Velcro Closures



NG - 4740 Police

Palm: Amara, Safety Rubber
Backside: Forway, Neoprene, Amara, Piping Nylon
Wrist: Neoprene, Rubber logo, Velcro Closures



NG - 4741 Police

Palm: Leather Goat (Aniline)
Backside: Nomex & Leather
Wrist: Nomex & Velcro Closures with Leather



NG - 4742 Tactical

Palm: Amara, Touch Function
Backside: Forway Printing
Wrist: Nylon Material Grip



NG - 4743 Tactical

Palm: Amara, Touch Function, Rubber logo Grip
Backside: Forway Printing, Amara, Elastic
Wrist: Elastic, Rubber logo, Velcro



NG - 4744 Tactical

Palm: Amara, Touch Function, Rubber logo Grip
Backside: Forway Printing, Amara, Elastic
Wrist: Elastic, Amara, Velcro



NG - 4745 Military, Police Winter

Palm: Leather
Backside: Neoprene
Wrist: Elastic, Rubber Logo & Velcro



NG - 4746 Military Police Winter

Palm: Silicon Amara Printing
Backside: Soft Shell, Zip
Wrist: Nylon Lycra Edge Piping



PRIVATE BRANDING art

When you are thinking to develop your own brand in gloves line NANBA GROUP would appear to be the best choice amongst its competitors. We discuss client's idea, develop final thought and impliment it in the form of finished products that turns to be simply marvelous in usage and appearing. Fits perfectly in manifold.

BlackOps



TacticalOps



Shooter



Development & Customization

NANBA understands the core of the idea that leaves much more meaning than what to be appear on the surface level. If you have something to customize, a speical development or a unique thought to turn into physical product, Let's discuss with us and we will develop it in reality to win the market place together. We are brand partners since years and this is due to creative skill we have.

NANBA
GROUP

www.nanbagroup.com





Thanksgiving NOTE

» THANKSGIVING NOTE

Dear Clients,

Thank you very much for your precious time to go through our catalogue, we really appreciate it and quite hopeful that you have enjoyed reading it, however, if there is something we have missed in this catalogue Or any suggestion you have that could improve us, please must share so that we may count in our next addition of catalogue and improve ourselves.

Simultaneously we always do our level best to assist our clientage in the best possible way both in services and products because we don't seek business for one time rather for years to come.

As a matter of fact, we are learning and improving every single moment and the appreciation, appropriate feedback, kind suggestions, a thorough elaboration; always give us a change to move to next level where our clients and we as manufacturer get into better ways to achieve apex in business.

We once again thank you from the bottom of our hearts for your time auspicious time.

Best Wishes

NANBA TEAM

NANBA

GROUP

www.nanbagroup.com



NANABA

GROUP

www.nanbagroup.com



NANABA



Jalal Pura, SIALKOT (51310) PAKISTAN.



E-mail: info@nanbagroup.com



Tel: +92 52 3611630-31



www.nanbagroup.com

